

LSR4328P, LSR4326P

Studio Monitors

Owner's Manual



Important Safety Instructions

1. Read these instructions.
2. Keep these instructions.
3. Heed all warnings.
4. Follow all instructions.
5. Do not use this apparatus near water.
6. Clean only with dry cloth.
7. Do not block any ventilation openings. Install in accordance with manufacturer's instructions.
8. Do not install near any heat sources such as radiators, heat registers, stoves or other apparatus that produce heat.
9. Do not defeat the safety purpose of the grounding type plug. A polarized plug has two blades with one wider than the other. A grounding type plug with two blades and a third grounding prong. The wide blade or the third prong is provided for your safety. If the provided plug does not fit into your outlet, consult an electrician for replacement of the obsolete outlet.
10. Protect the power cord from being walked on or pinched particularly at plugs, convenience receptacle and the point where the power cord connects to the apparatus.
11. Only use attachments/accessories specified by the manufacturer.
12. Use only with the cart, stand, tripod bracket, or table specified by the manufacturer, or sold with the apparatus. When a cart is used, use caution when moving the cart /apparatus combination to avoid injury from tip-over.
13. Unplug this apparatus during lightning storms or when unused for long periods of time.
14. Refer all servicing to qualified service personnel. Servicing is required when the apparatus has been damaged in any way, including: power-supply cord or plug is damaged, liquid has been spilled or objects have fallen into the apparatus, the apparatus has been exposed to rain or moisture, does not operate normally, or has been dropped.
15. The appliance coupler of the power supply cord is used as the ultimate disconnect device from the mains. The appliance coupler shall remain readily operable.
16. The apparatus shall be connected to mains socket outlet with a protective earthing connection.



WARNING:

- To reduce the risk of fire or electrical shock, do not expose the apparatus to rain or moisture.
- The apparatus shall not be exposed to dripping or splashing and no objects filled with liquids, such as vases, shall be placed on the apparatus. As with any electronic product, use care not to spill liquids into any part of the system. Liquids can cause a failure and/or a fire hazard.

Explanation of Graphic Symbols



The exclamation point within an equilateral triangle is intended to alert the users to the presence of important operating and maintenance (servicing) instructions in the literature accompanying the product.



The lightning flash with the arrowhead symbol, within an equilateral triangle, is to alert the user to the presence of insulated "dangerous voltage" within the products enclosure that may be of sufficient magnitude to constitute a risk of electric shock to humans.



CAUTION: TO REDUCE THE RISK OF ELECTRONIC SHOCK - DO NOT REMOVE COVER. NO USER SERVICEABLE PARTS INSIDE. REFER SERVICING TO QUALIFIED PERSONNEL. DO NOT EXPOSE THIS APPARATUS TO RAIN OR MOISTURE.



ATTENTION: POUR EVITER LES RISQUES DE CHOC ELECTRIQUE, NE PAS ENLEVER LE COUVERCLE. AUCUN ENTRETIEN DE PIECES INTERIEURES PAR L'USAGER. CONFIER L'ENTRETIEN AU PERSONNEL QUALIFIE. AVIS: POUR EVITER LES RISQUES D'INCENDIE OU D'ELECTROCUTION, N'EXPOSEZ PAS CET ARTICLE A LA PLUIE OU A L'HUMIDITE.

Table Of Contents

Safety Instructions	iii
Introduction.....	1
Quick Start	5
Reference	9
Front Panel	9
Rear Panel.....	16
Remote Control	18
Speaker Placement	20
AC Power Connections	21
Network Connections and DIP Switch Settings	21
Audio Connections	23
RMC Room Mode Correction	24
Performing An RMC Calibration	25
Equalization	28
Restoring Factory Settings	30
LSR4300 Control Center Software	30
Appendix A: EQ Presets	31
Appendix B: System Block Diagram	33
Appendix C: Wiring Requirements	34
Appendix D: Mounting Specifications.....	37
Appendix E: SPL Calibration.....	38
Appendix F: Error Messages and Troubleshooting	39
Specifications	41
Warranty Statement.....	44
JBL Professional Contact Information	46

Introduction

Congratulations on your purchase of JBL LSR4300 Series Studio Monitors, the most advanced loudspeaker system ever developed for critical listening.

We know that very few people read owner's manuals from cover to cover, so we've organized this one to make it easy to find the information you need.

The **Features** section on the next page provides a brief overview of the exceptional features of the LSR4300 Series. It's followed by a **QuickStart** section, which will get you up and running in a matter of minutes.

Once you've got your LSR4300 system powered up and delivering sound, you should turn to the **Reference** section, which describes every feature and function of the LSR4300 in detail. Finally, we've included a number of technical appendices and specifications at the end of this manual.

Note that this manual covers the model LSR4328P and LSR4326P Studio Monitors. Separate owner's manuals are provided for the model LSR4312SP Subwoofer and for the LSR4300 Control Center software.

Manual Conventions

The following conventions will be used in this owner's manual:

◀ Especially important tips and cautions will be presented like this.

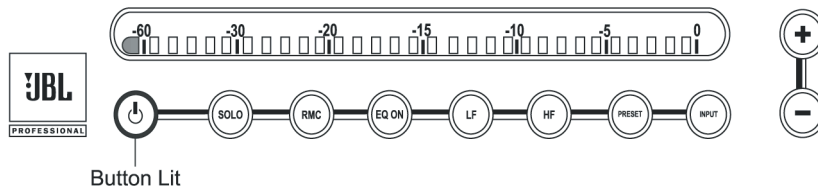

Button Lit

Indicates that a button is lit.

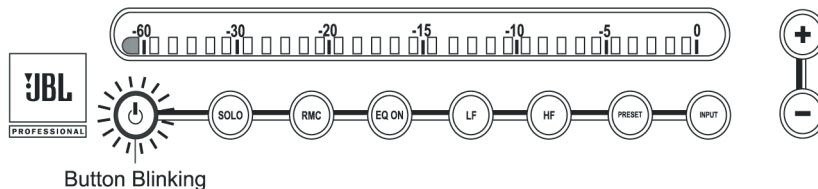

Button Blinking

Indicates that a button is blinking.

Introduction - Features



Indicates that an LED is lit green.

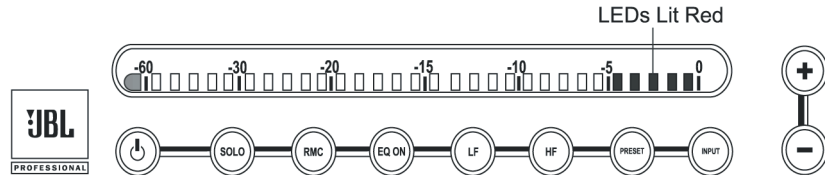

Indicates that an LED is lit red.

Features

The LSR4300 Series combines stunning sound and legendary JBL design with innovative new technologies. The end result is a product that is nothing short of revolutionary – a monitoring system suitable for use in the most demanding music, broadcast, and postproduction applications.

RMC™ Room Mode Correction

The biggest challenge for anyone producing audio is creating a mix that sounds great on all playback systems. If you think of a monitoring system as a kind of “lens” through which you hear sound, the object is to have the lens be crystal-clear and transparent so that it imparts no coloration whatsoever to the signal being played back. However, every loudspeaker system, no matter how well designed, interacts with the room in which it is installed. Lack of correct acoustic treatment (or, worse yet, lack of any treatment at all) can result in anomalies such as resonant frequencies and low-frequency “standing waves” – the aural equivalent to the lens being “smeared.” Trying to create a mix in such an environment can be as frustrating and difficult as trying to paint a masterpiece while blindfolded.

JBL’s exclusive second generation RMC™ Room Mode Correction technology is designed to solve the problem. A powerful onboard computer in each LSR4300 Series monitor automatically analyzes the frequency response of your room and compensates for low frequency inaccuracies in the listening space by precisely inserting filters so that low frequency signals arrive at the mix position with the intended frequency response. In effect, the LSR4300 Series goes “beyond accurate,” allowing you to eliminate the guess-work and create reliable mixes that translate to any environment. Additionally, the RMC system trims the level of each speaker to compensate for differences in placement relative to the mix position, ensuring balanced mixes.

HiQnet™ Networking

The LSR4300 Series also incorporates the new Harman HiQnet™ protocol that networks all the speakers in a system together and allows full control from the provided wireless remote control or from any computer via a standard USB connection and LSR4300 Control Center Software. With the push of a button or the click of a mouse you can change the system level, choose from any of three different inputs (one analog and two digital), mute and solo individual speakers, and make low and high frequency EQ adjustments.

LSR Linear Spatial Reference Design

The LSR4300 builds on the Linear Spatial Reference technology that has made our LSR6300 Series of studio monitors so popular in recording, broadcast, and postproduction facilities worldwide. The exact geometry of the wave guide, the interaction of the woofer and tweeter, and the final assembly of the injection-molded parts has been redesigned from the ground up to provide accurate off-axis as well as on-axis listening, within a window of +/-30 degrees horizontal, +/- 15 degrees vertical. Attention to these critical aspects results in neutral mid and high frequency response at the mix position and a sound which is smooth and accurate in a wide variety of acoustic spaces.

Surround Smart

The LSR4300 Series is ideal for surround sound use. Up to eight main speakers – any combination of LSR4326 6-inch and LSR4328 8-inch models – and up to two LSR4312SP subwoofers can be easily configured for LCRS, 5.1, 6.1, 7.1 SDDS and larger mixing and monitoring applications.

Once all LSR4300 monitors are in place, RMC and HiQNet automatically aligns the entire system, setting relative volume so that the sound from all channels is balanced when it arrives at the mix position. The end result is precise imaging regardless of each monitor's actual physical placement.

In addition, the ability to centrally control the volume of all the speakers (via the supplied wireless remote control or LSR4300 Control Center software) is particularly useful in surround sound applications where the recording system does not provide a multi-channel monitor volume control, or where adjustable volume is not available when using the mixing system's digital outputs. Similarly, the ability to selectively mute or solo channels and to remotely switch between three digital and analog input sources enhances system capabilities by allowing you to monitor not only the main recording system, but also any two additional connected sources such as DVD and CD players, multi-channel processors and encode-decode units. This alleviates the need to purchase additional outboard monitoring hardware.

Selectable Inputs

In this age of digital workstations and control surfaces, it isn't enough to simply provide an input jack. The LSR4300 offers three separate inputs: stereo high-resolution 96 kHz AES/EBU and S/PDIF digital inputs, as well as dual balanced analog XLR and ¼-inch inputs with selectable +4dBu / -10dBV sensitivity. This allows it to accommodate a wide range of input sources, including digital workstations, CD players, DVD players, and multi-channel processors. What's more, you can easily select between inputs with the push of a single button (on either the front panel or the wireless remote) or click of a mouse (via an attached computer and the included LSR4300 Control Center software).

Introduction - Features

Onboard Bi-amplification

LSR4300 Series monitors are self-powered, eliminating the need for external amplifiers. Perfectly matched bi-amplification is provided onboard, with 150 watts of power for the woofer and 70 watts for the high frequency transducer.

Other Features

- Custom designed transducers specially engineered to deliver clean, crisp sound. The LSR4328P model features an 8-inch low frequency woofer, while the LSR4326P model offers a 6.25-inch woofer, both coupled with a 1-inch soft-dome high frequency transducer. All transducers are self-shielded, with Neodymium motor structures for exceptional transient response and superb power handling.
- Advanced front-panel user interface allows control of system functions such as volume, input selection, user EQ and EQ presets, RMC calibration and bypass, individual speaker solo, and brightness level of the meter and buttons.
- Front panel meters show continuous output levels in dBFS to serve as a visual reference of the speaker's contribution when measured at the mix position.
- Integrated mounting points allow wall mounting of speakers when space limitations prohibit the use of speaker stands.
- Built-in side handles make positioning and transporting of speakers easier.

Quick Start

Each LSR4300 speaker includes:

- One speaker
- CAT5 networking cable
- AC power cord
- This owner's manual

The LSR4326/PAK and the LSR4328P/PAK include:

- Two speakers, each with the above items
- LSR4300 Accessory Kit containing:
 - o Calibration microphone and mic clip
 - o Infrared wireless remote control
 - o LSR4300 Control Center Software
 - o 16-foot USB Cable
 - o Two network terminators
 - o Two AAA Batteries

Here are simple step-by-step instructions to get you up and running quickly:

1. Unpack the speakers. To avoid damage to the speaker elements, open the top of the box, keep the Styrofoam end cap on, and roll the box upside down. The box can then be slipped off. (This also works in reverse for repacking the units.)

⚠ Be sure to not grasp the monitors from the front. A stray hand or finger can cause damage to the high frequency transducer that is located near the top of the cabinet on the front baffle.

2. Position each speaker in the room. (See page 30 in this manual for speaker placement tips.)

Quick Start

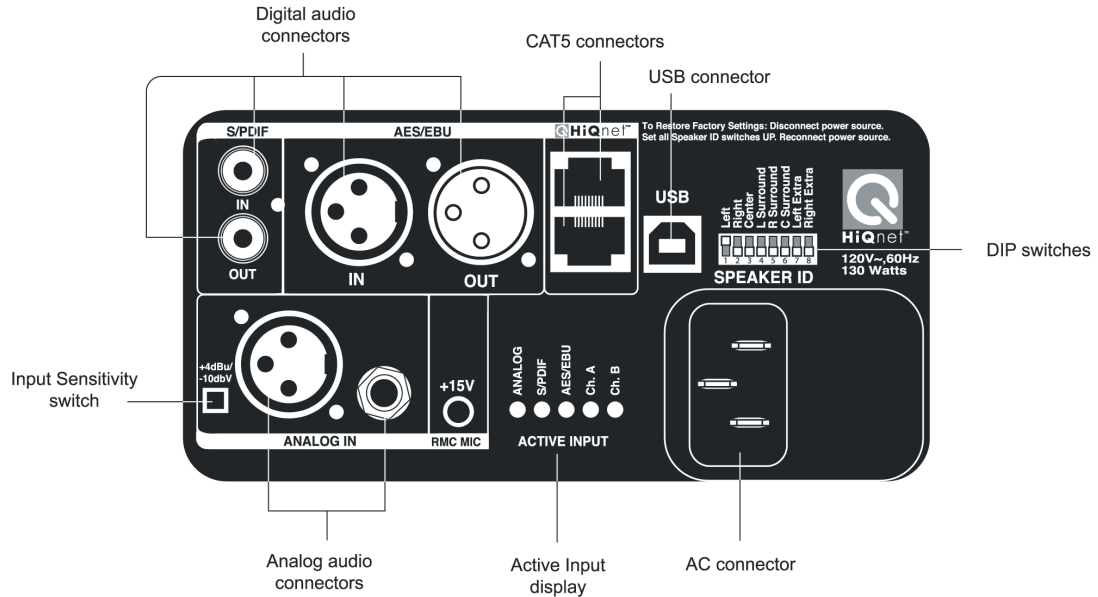

LSR4300 Rear Panel

3. Connect each speaker to a suitable power source using the supplied AC power cable. (See page 23 in this manual for more information.)
4. Connect the speakers together in any order using the supplied CAT5 cable. Plug one end of the cable into either of the two HiQnet ports on one speaker and the other end into a HiQnet port on another speaker until all speakers are connected. Connect the two supplied ethernet terminators to the first and last speakers in the chain. (See page 21 in this manual for more information on networking your LSR4300 monitors.)
5. Set the Network ID DIP switch on the rear panel of each speaker so that it corresponds to the channel for which the speaker is to be used. For example, place the DIP switch labeled LEFT in the up (ON) position for the speaker reproducing the left channel, and place the DIP switch labeled RIGHT in the up (ON) position for the speaker reproducing the right channel. (See page 22 in this manual for more information.)

⚠ Make sure that one, and only one, DIP switch is placed in the up (ON) position for each speaker. One speaker in the system must have the LEFT DIP switch set to the ON position.

6. Make all required audio connections to the rear panel of your monitors. Both the LSR4328P and LSR4326P models are both able to accommodate one analog and two digital input signals. (See page 23 in this manual for more information on audio connections.)
 - a. If you are connecting an analog signal (i.e. from the line level analog outputs of a mixing console, workstation, CD player, or DVD player), use appropriate cabling to make a connection between the device and either the rear panel Analog XLR connector or 1/4" connector, then set the rear panel Input Sensi-

tivity switch to +4dBV (switch IN) or -10dBu (switch OUT) to match the nominal level of the signal source. If you don't know how to set the switch, consult the documentation for the signal source. Most professional devices operate at +4dBV while most consumer devices operate at -10dBu. (See page 24 in this manual for a wiring diagram.)

Do **NOT** make connections to both the XLR and 1/4" analog connectors; use one or the other.

- b. If you are connecting digital signals (i.e., from a digital console or workstation, or from the digital outputs of a CD or DVD player or processor), use appropriate cabling to make a connection between the device and the rear panel AES/EBU (XLR) or S/PDIF (phono) input of the speaker designated to carry the LEFT channel (i.e., the left speaker in a stereo setup). Then use appropriate cabling to make a connection between the rear panel AES/EBU (XLR) or S/PDIF (phono) output of the left speaker and the rear panel AES/EBU or S/PDIF input of the speaker designated to carry the RIGHT channel (i.e., the right speaker in a stereo setup). (See page 24 in this manual for a wiring diagram.)

When using digital audio inputs, the rear panel DIP switch settings determine which channel of the stereo AES/EBU or S/PDIF signal will be reproduced by each speaker.

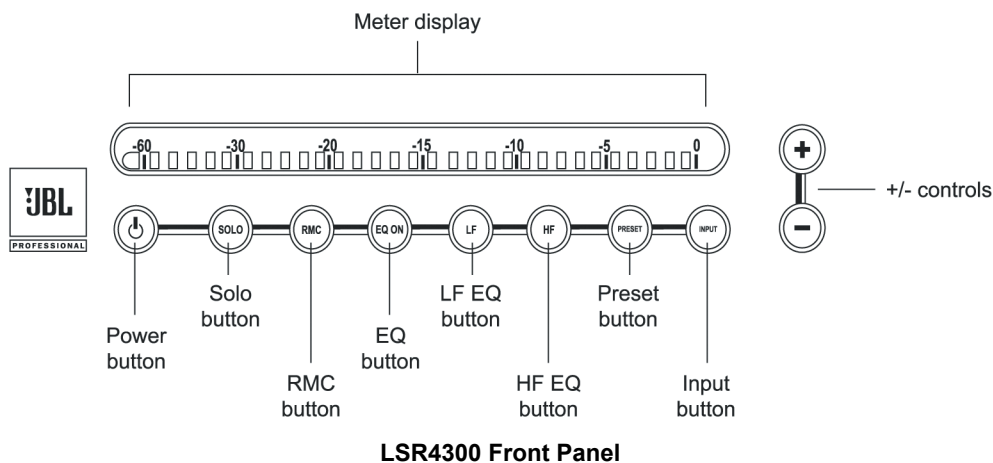

7. Press the front panel INPUT button on any speaker so that it begins blinking. While it is still blinking, press the + / - controls on any speaker to select the desired input. The front panel LEDs and the rear panel ACTIVE INPUT display shows which of the three inputs (Analog, S/PDIF, or AES/EBU) is currently selected. If a digital input is selected, the rear panel ACTIVE INPUT display also shows which channel is being reproduced by that speaker.

Quick Start

8. Power up your signal source, then press the front panel POWER button on any speaker. All speakers in the system will power on (the JBL Logo will go from dimly to brightly lit.)

◀ To avoid “thumps” which can damage your speakers, always power up the signal source FIRST and your LSR4300 monitors LAST.

9. Set the initial speaker volume by pressing the + / - controls on any speaker. All speakers in the system will go to the designated volume. As the volume is increased, additional LEDs light. We recommend beginning with a modest volume setting, so that only the first ten LEDs or so (up to the “-20”) mark are lit.
10. Play a signal source and adjust the final speaker volume to a comfortable listening level by pressing the + / - controls on any speaker.
11. If your LSR4300 system is brand new, the RMC button on the front panel of all speakers will be lit, indicating that Room Mode Correction has not yet been performed. To calibrate your speakers with RMC, begin by attaching the provided calibration microphone to a mic stand and place the mic at the mix position, oriented vertically. Then connect the microphone to the Left speaker’s RMC MIC rear panel input.

◀ To perform an RMC analysis, the calibration microphone must be connected to the speaker designated as “Left” (LEFT DIP switch up).

12. Press and hold the RMC button on any speaker, then walk to a spot in the room where you are not blocking the path between the microphone and any speaker. Each speaker will emit a reference tone in turn and its meter will show a left-to-right “chase” pattern that indicates the system is calibrating. When the “chase” pattern on the meters stops, the process is complete. You can compare the effects of RMC with the uncorrected response by pressing the RMC button on the front panel of any speaker. When the button is lit, RMC correction is being bypassed and you hear the uncorrected response; when the RMC button is unlit, the RMC is active and compensating for any acoustic deficiencies in your listening environment. (See page 25 in this manual for a step-by-step description of the RMC calibration procedure.)

◀ The RMC procedure produces a fairly loud swept sine wave calibration tone that can surprise you when you hear it for the first time. After pressing the RMC button, move away from the speaker. There is a five second delay prior to the sounding of the calibration tone.

13. Place the provided batteries in the wireless remote control, and, if you want to establish computer control over your LSR4300 system, make a USB connection between your computer and the LEFT speaker and then install the provided LSR4300 Control Center Software.
14. Finally, put on some good music to listen to and take a few moments to read the rest of this manual to acquaint yourself with all the features of your JBL LSR4300 system. Enjoy!

Reference

Overview

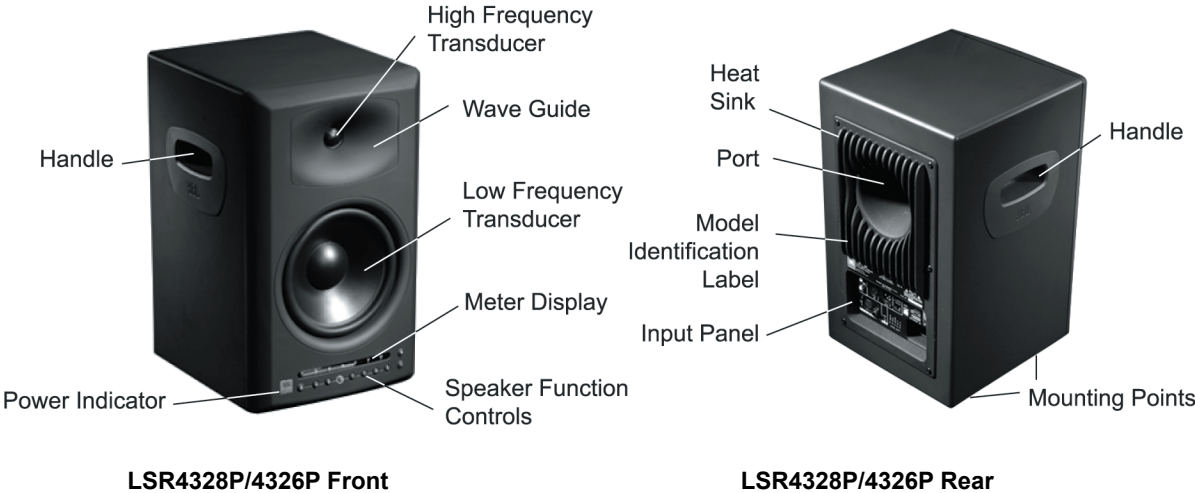

LSR4328P/4326P Front

LSR4328P/4326P Rear

Front Panel

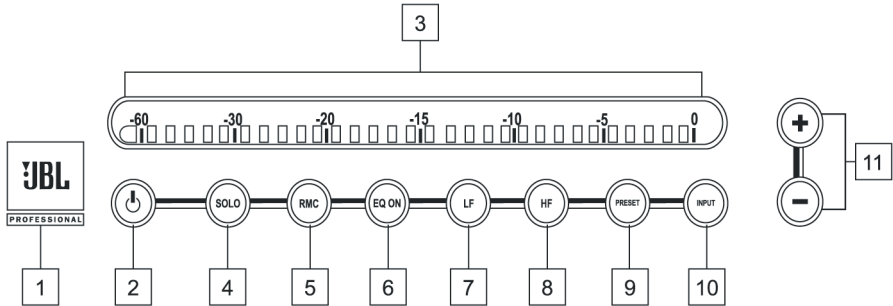

LSR4328P/4326P Front Panel

The controls and displays on the front panel of the LSR4300 allow you to adjust and view various speaker settings. Below is a listing and description of each.

1. **Power Indicator** – The JBL logo lights at two different levels. It is illuminated dimly whenever the LSR4300 is connected to an AC power source, indicating the speaker is in “standby” status. It is illuminated at full brightness when the speaker is powered up and active.

Reference - Front Panel

- Power** – After connection to an AC power source, press this button to turn the speaker on. If networked together with other speakers, all speakers will turn on simultaneously. Press the button again to return the speaker to a low-power stand-by mode, where the internal amplifiers are turned off and all user functions are deactivated. As shown below, when the speaker is powered on and active, the JBL logo will be brightly lit (see #1 above) and the left-most meter segment will be lit:

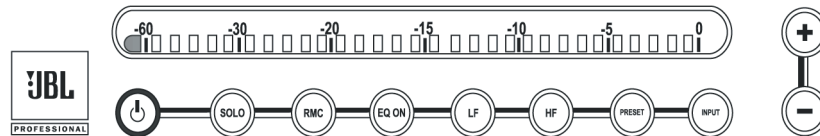

- Meter Display** – In combination with front panel buttons, the meter is used to display the current setting and status of the following functions:
 - SOLO function (see #4 below)
 - Progress of RMC calibration process (see #5 below)
 - LF and HF EQ boost and attenuation (see #6, #7 and #8 below)
 - EQ preset selection (see #9 below)
 - Input source selection (see #10 below)
 - Overall system volume (see #11 below)
 - Meter and button brightness (see #11 below)
 - Error conditions

The meter has 31 three-color segments that can illuminate in green, amber or red. For many of the above operations, all 31 segments light green only. However, when audio signal is being reproduced by the speaker, all three colors are used and the meter is calibrated to indicate the continuous output in decibels (dB) below the speaker's full output capability. Green LEDs indicate signal 8 dB (or more) below clipping; amber, approximately 7 to 4 dB below clipping; and red, approximately 3 to 0 dB below clipping. The segment furthest to the right ("0") illuminates red when the input signal is has reached its maximum value (greater than -1.5 dBFS) and causes clipping of the electronics.

🔊 The LSR4300 models include protective limiting. Limiting occurs when the output signal exceeds -2 dBFS or the second LED from the right is illuminated (in the LSR4328P) or -5 dBFS or the fifth LED from the right is illuminated (in the LSR4326P).

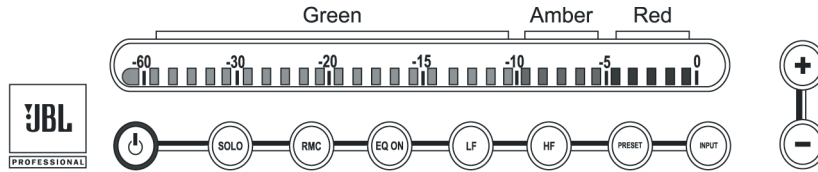

▶ You can calibrate your LSR4300 system so that the meter display will show how much SPL the speaker is contributing at the listening position. For more information, see Appendix E on page 38 in this manual.

4. **SOLO** – Press this button to mute the signal on all other speakers. As shown below, when this function is active, the SOLO button will flash on the selected speaker.

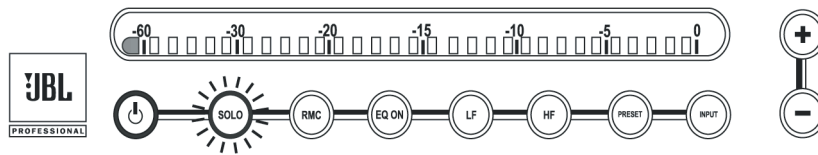

At the same time, the SOLO buttons on all other networked speakers (those that are muted) will light steadily, and their left-most meter segments will flash to indicate a muted state:

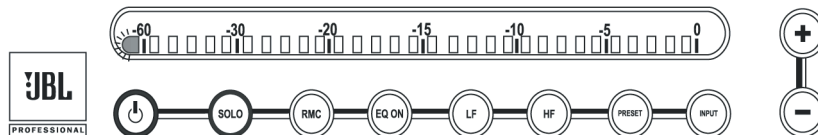

To end solo and unmute all other networked speakers, press the SOLO button for that speaker again.

▶ All front panel button actions can be cancelled at any time simply by pressing the button a second time.

5. **RMC** Room Mode Correction – This button is used both to initiate an RMC calibration and to bypass it after it has been performed (in order to compare the results of RMC with the uncorrected signal). To initiate RMC calibration, press this button and hold it for three seconds or longer. (During calibration, the button flashes.) For more information about RMC and the RMC calibration procedure, see pages 24 through 28 in this manual.

Reference - Front Panel

When a brand new LSR4300 speaker is first powered on or if its factory settings have been recalled (see page 30 in this manual), the RMC button lights steadily to indicate that an RMC calibration needs to be performed. For more information, see page 25 in this manual.

- EQ** – Pressing this button allows you to enable or bypass the LSR4300 equalization. When the button is lit, EQ is active.

When EQ is ON, the LF and/or HF buttons will also light if the current setting includes LF or HF boost or cut.

- LF** (Low Frequency) boost / cut – Allows you to apply +/- 2 dB of low frequency equalization. Press this button to activate LF EQ; it will flash. While flashing, press the + button to increase the amount of LF EQ in 0.25 dB steps or press the – button to decrease the amount of LF EQ in 0.25 dB steps. For more information, see page 28 in this manual.

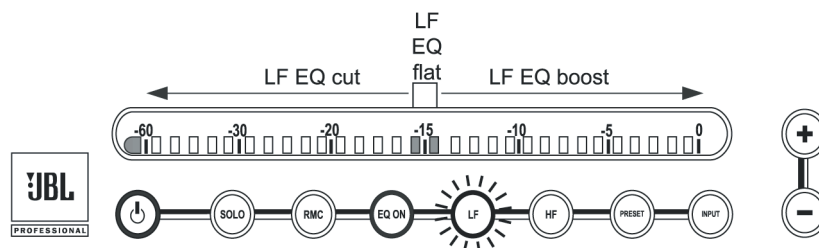

Once set, the LF and EQ buttons will remain illuminated to indicate that LF equalization has been applied.

- HF** (High Frequency) boost / cut – Allows you to apply +/- 2 dB of high frequency equalization. Press this button to activate HF EQ; it will flash. While flashing, press the + button to increase the amount of HF EQ in 0.25 dB steps or press the – button to decrease the amount of HF EQ in 0.25 dB steps. For more information, see page 28 in this manual.

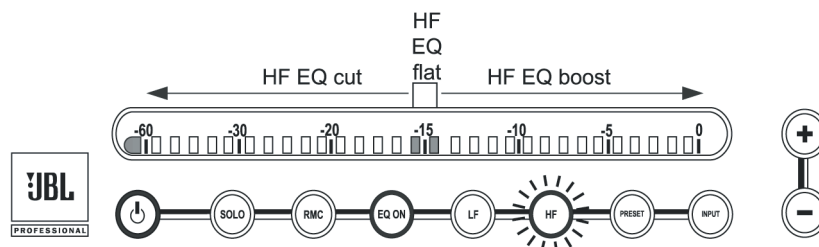

Once set, the HF and EQ buttons will remain illuminated to indicate that HF equalization has been applied.

9. **PRESET** – Allows you to select and activate one of six factory EQ presets, or a seventh “current setting” preset. To recall a preset, press the PRESET button. It will flash. While flashing, use the + or – buttons to select the desired preset.

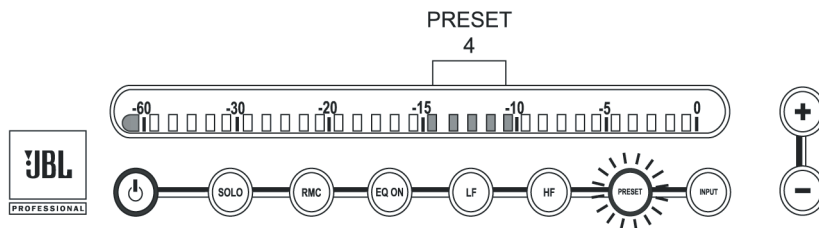
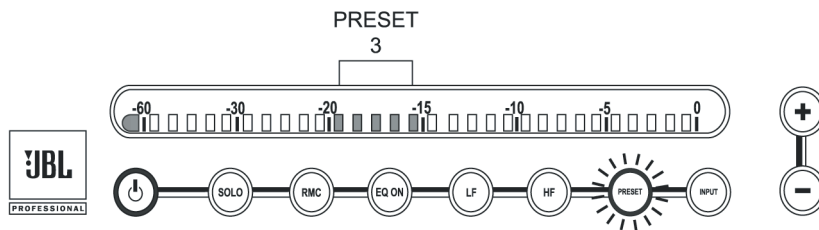
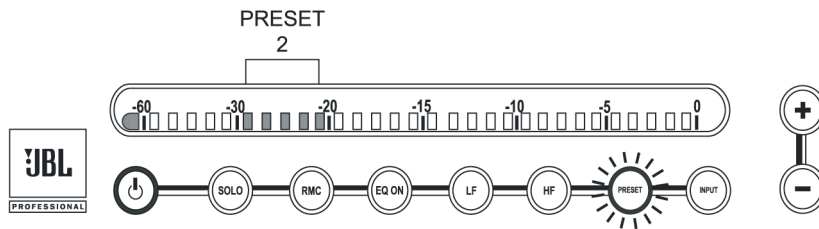
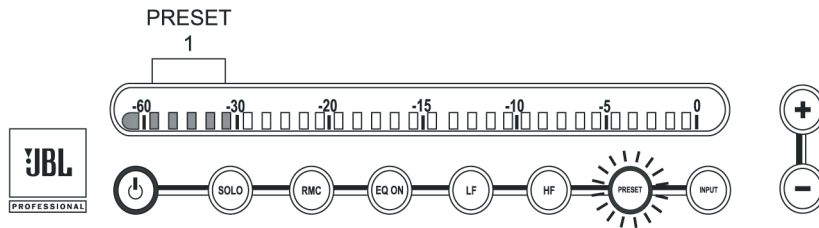
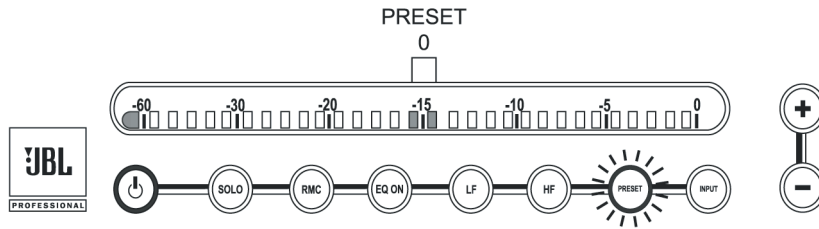

Reference - Front Panel

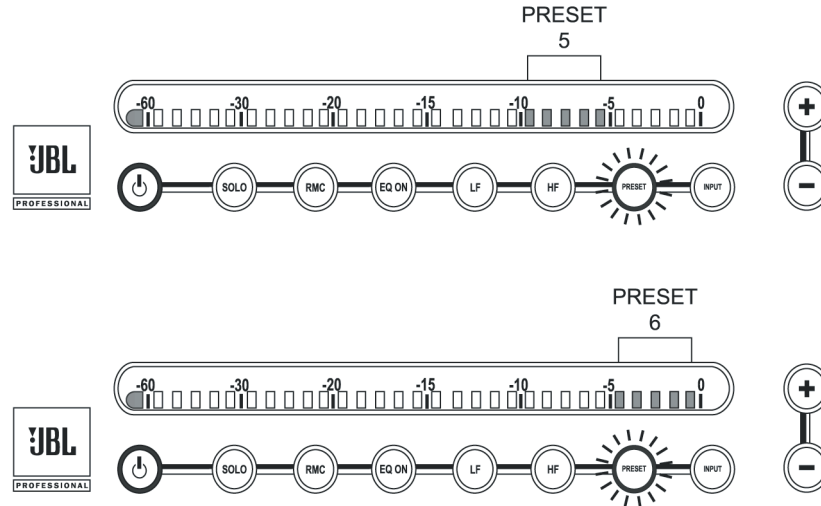

When a preset is selected, the LF and HF buttons will illuminate to indicate whether the currently selected preset has LF and/or HF boost or cut. The preset becomes active when the PRESET button stops flashing (after approximately 3 seconds). If no preset is selected during that time (that is, the +/- buttons have not been pressed), or if you select Preset 0, or if you press the PRESET button a second time, the system will return to its current settings. For more information, see page 28 in this manual. A complete listing of factory preset parameters can be found in Appendix A.

▶ A preset can be deactivated by pressing the EQ ON button until the light goes out, or by manually setting both the LF and HF values to 0 dB.

- INPUT (Input Select)** – Allows you to listen to any of three connected signal sources (analog, S/PDIF digital or AES/EBU digital). To select an input source, press the INPUT button. It will flash and the meter display will confirm the currently selected input source. In addition, incoming signal will temporarily be muted. While the INPUT button is flashing (for approximately 3 seconds), you can use the +/- buttons to change the input source. The newly selected input source will then be confirmed on the meter display, and after a brief pause, the input signal will resume. To maintain the same input source and cancel the operation, either press the INPUT button a second time or wait for the 3-second “time-out” to end without pressing the +/- buttons.

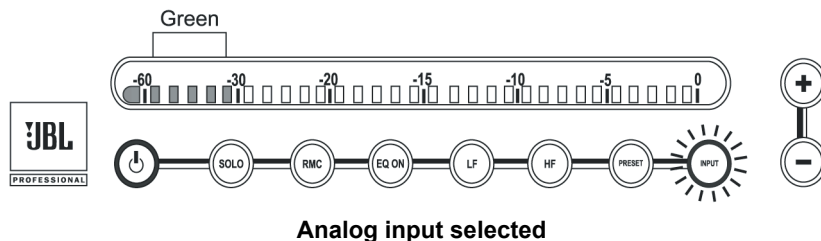

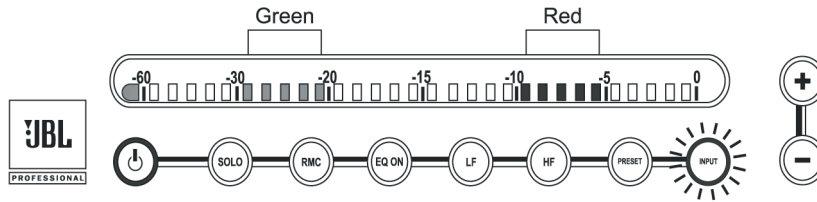

S/PDIF input selected (channel A)

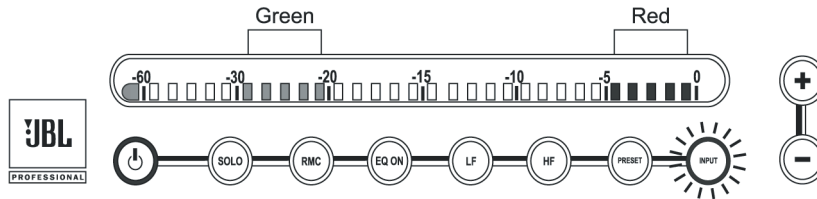

S/PDIF input selected (channel B)

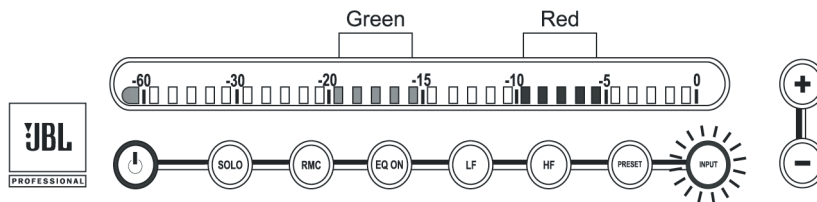

AES/EBU input selected (channel A)

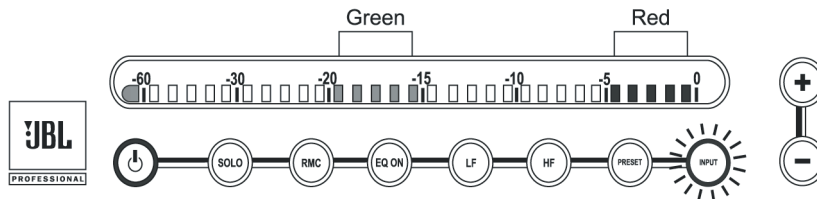

AES/EBU input selected (channel B)

After changing the input source, the Active Input display on the rear panel will indicate the current selection.

◀ When monitoring digital (S/PDIF or AES/EBU) signal, the rear panel DIP switches must be set correctly in order to determine which channel is being reproduced. For more information, see page 23 in this manual.

◀ If you select a digital input to which no signal is connected, no signal will be heard, and the left-most meter segment will flash to indicate an error condition.

Reference - Rear Panel

11. **+/-** – These increment/decrement buttons have different functions, depending upon whether a front panel button is flashing or not. If a front panel button is flashing, they are used to increment or decrement the value of the selected parameter. (For example, if the PRESET button is flashing, the +/- buttons step through the various equalization presets.) If no front panel button is flashing, the +/- buttons adjust the overall system volume. (Press the + button to increase system volume and the – button to decrease system volume.)

In addition, by pressing both the + and – buttons at the same time, they can be used to alter the brightness of all front panel buttons and the Meter Display. There are six settings; at the lowest setting, all buttons and meter segments are completely off, and only the JBL logo glows to indicate power.

Rear Panel

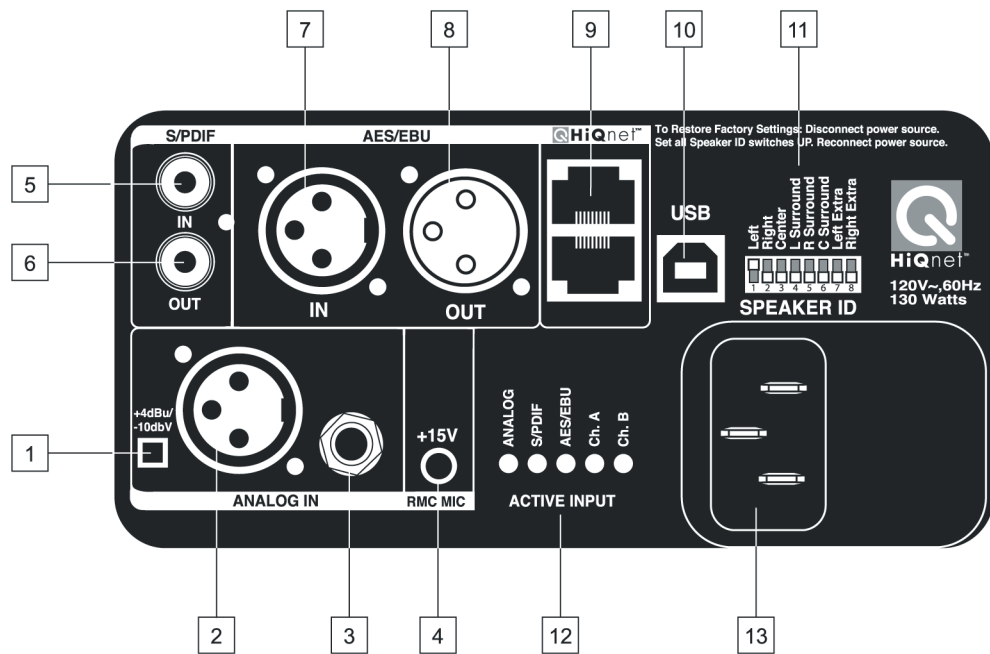

LSR4328P/ LSR4326P Rear Panel

1. **Input Sensitivity switch** – In the OUT position, selects -10 dBV sensitivity for the analog input. In the IN position (pressed in), selects +4 dBu sensitivity for the analog input.
2. **Analog XLR Balanced input connector.** Connect analog audio input signal here.
3. **Analog 1/4" Balanced input connector.** Alternatively, analog audio input signal can be connected here. **CAUTION: Use either the 1/4" or the XLR input, Do not connect sources to both analog inputs simultaneously.**

▶ Positive voltage to Pin 2 of the XLR connector or the tip of the 1/4" jack will produce a forward motion in the speaker cone. See Appendix C in this manual for wiring diagrams.

4. **RMC Microphone Input** – 1/8" connector for the supplied RMC calibration microphone. **CAUTION: This input connector provides +15 volts of phantom power, so be sure to not connect any device other than the supplied RMC calibration microphone to this connector.**
5. **S/PDIF input connector** (phono) – Input connector for incoming digital signal in two-channel S/PDIF Format
6. **S/PDIF output connector** (phono) – Output connector used to route incoming S/PDIF signal to another speaker.
7. **AES/EBU input connector** (XLR) – Input connector for incoming digital signal in two-channel AES/EBU Format
8. **AES/EBU output connector** (XLR) – Output connector used to route incoming AES/EBU signal to another speaker.
9. **Harman HiQnet connectors** (RJ45 x 2) – Used to interconnect LSR4300 speakers together for centralized system control from any speaker or the provided wireless remote control or LSR4300 Control Center Software.
10. **USB connector** – Universal Serial Bus Type I connector for computer connection when using the provided LSR4300 Control Center software.
11. **DIP switches** – These eight switches are used to identify the channel being carried by each speaker in a networked system. If one of the two digital inputs is being monitored, the DIP switch setting also determines whether the speaker is reproducing the left (Channel A) or right (Channel B) side of the incoming stereo signal. In normal operation, only one DIP switch should be in the up (“on”) position for each speaker. For more information, see page 21 in this manual.

◀ DIP switches are also used to restore factory settings. See page 30 in this manual for more information.

12. **ACTIVE INPUT display** – Whenever the monitor is powered on, one of these LEDs will be lit, indicating whether the speaker is reproducing signal arriving at the analog input, or one of the two digital inputs (S/DIF and AES/EBU). If one of the two digital inputs is being used, the display also shows whether the speaker is reproducing the left (Channel A) or right (Channel B) side of the incoming stereo signal. For more information, see page 23 in this manual.
13. **POWER connector** – Accepts the supplied IEC power cable.

Remote Control

The provided infrared wireless remote control allows you to make adjustments to your LSR4300 system without leaving the mix position. The remote control duplicates all the controls found on the speaker front panel (such as power on, volume adjust, soloing, input select, EQ adjustment and preset selection) and adds the following extra functions:

- A dedicated brightness control
- System volume DIM function

When a function is selected using the remote control, the corresponding indicator on the speaker front panel illuminates to confirm the selection.

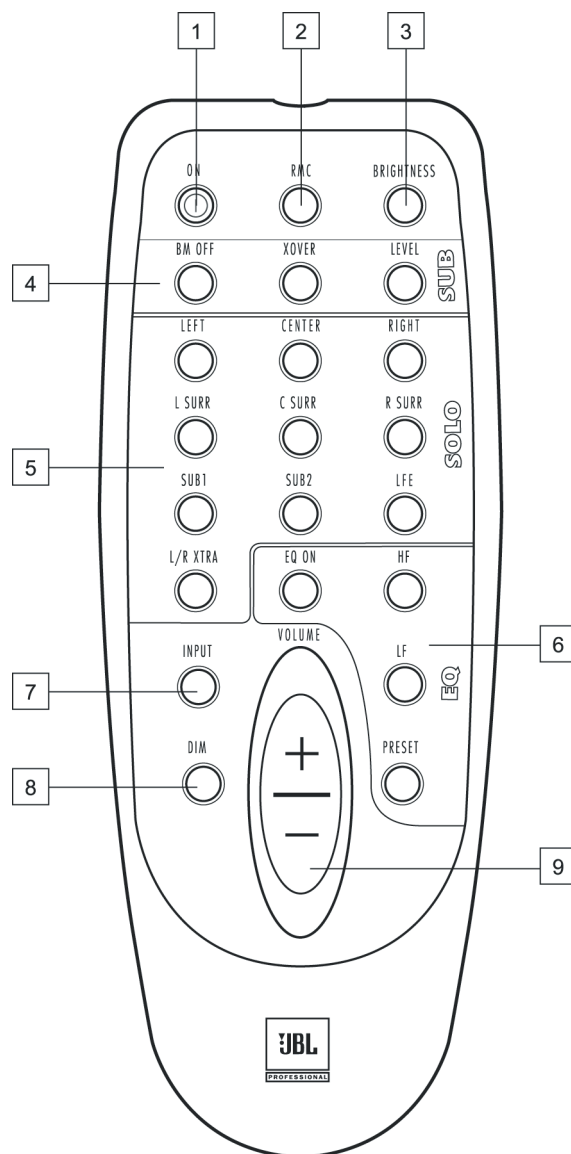

Remote Control

◀ When using the remote control with a networked system, always aim it at the LEFT speaker.

1. **ON** – Duplicates the function of the front panel POWER control.
2. **RMC** – Press to bypass RMC settings. (The front panel RMC buttons will light.) Press again to reactivate RMC settings.

◀ The remote control cannot be used to initiate the RMC calibration process.

3. **BRIGHTNESS** – Press this button and then use the remote control Volume (+/-) button to increase or decrease the brightness of the speaker front panel controls and meter display.
4. **SUBWOOFER** controls – These controls have no function with LSR4328P and LSR4326 monitors; they are used to access various features of the LSR4312SP subwoofer.
5. **SOLO** controls – Solos the selected speaker.
6. **EQ** controls –
 - a. **EQ ON** – Duplicates the function of the front panel EQ control.
 - b. **HF** - Duplicates the function of the front panel HF control.
 - c. **LF** - Duplicates the function of the front panel LF control.
 - d. **PRESET** - Duplicates the function of the front panel PRESET control.

◀ After pressing any of the EQ controls on the remote control, be sure to press the Volume (+/-) control afterwards in order to make any required changes.

7. **INPUT** - Press this button and then use the remote control Volume (+/-) button to change the input source.
8. **DIM** – When pressed, attenuates the volume of the entire system by 12 steps (equivalent to 12 dB when volume is set to full).
9. **VOLUME +/-** - Has two functions:
 - a. When none of the above buttons is pressed, increases and decreases overall system volume.
 - b. In conjunction with the button functions described above, increments or decrements the value of the currently selected function.

Speaker Placement

The design of the LSR4300 system lends itself to a wide variety of placement options. Covered here is a typical stereo setup for near- to mid-field monitoring, where the mix position is generally 1 to 1.5 meters (3 to 5 feet) away from the speakers.

While the exact stereo listening angle is largely a matter of personal preference, we recommend the monitors be arranged to form an equilateral triangle as shown in the illustration below.

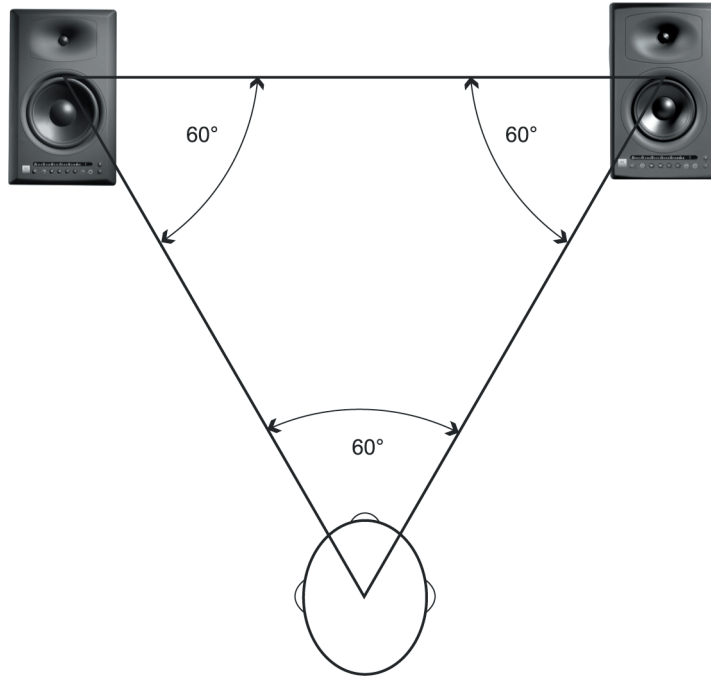

Recommended stereo speaker positioning

The center of the high-frequency transducer should be at the same height (on-axis) as the ear level of the listener. Ideally, they should be placed on suitable speaker stands and well away from boundaries such as walls, ceilings, and large pieces of furniture. The LSR4328P and LSR4326P are equipped with mounting points, to allow wall and ceiling mounting using industry-standard mounting hardware. See Appendix D on page 37 in this manual for details.

🔊 LSR4300 Series monitors are designed to be positioned vertically and not horizontally. This orientation provides optimum dispersion over the widest listening angle and eliminates the phase shift that can occur when the relative distances between the woofer, tweeter and the listening position are altered. Horizontal placement directs high-frequency response into the work surface causing destructive cancellation resulting in inaccuracies in the frequency response.

AC Power Connections

The LSR4300 voltage is set at the factory for use with either 100V-125V (U.S.) or 200V-250V. The ground terminal of the IEC plug is required by wiring codes and regulations. It must always be connected to the electrical installation safety ground. **CAUTION: Do not use three-pin-to-two-pin AC adapters to defeat the ground.**

The LSR4300-Series units have carefully designed internal grounding and balanced inputs and outputs to reduce the possibility of ground loops (hum). If hum occurs, see Appendix C on page 34 in this manual for suggested audio signal wiring, system grounding hints and other preventive measures.

Network Connections and DIP Switch Settings

The Harman HiQnet™ networking technology employed by the LSR4300 enables a number of unique capabilities. When speakers are interconnected using HiQnet, you can make changes to all speakers in the system simply by adjusting the controls of any one speaker. For example, turning on the power to one speaker causes them all to power up; similarly, by changing the volume of one speaker, an equal volume change is made in all speakers.

HiQnet networking also allows RMC calibration for all speakers to be accomplished with the push of a single button, with the supplied calibration microphone connected to a single speaker. It also makes it possible for all speakers in the system to be controlled using the supplied wireless remote control and/or LSR4300 Control Center Software. Up to eight LSR4328P or LSR4326P speakers can be interconnected in a single network. HiQnet enables coordinated RMC calibration so sound arriving at the mix position from all speakers is precisely balanced.

To network your LSR4300 system:

1. Interconnect all speakers using the supplied CAT5 cable. Plug one end of the cable into either of the two HiQnet ports on one speaker and the other end into a HiQnet port on another speaker until all speakers are connected. (Speakers can be connected in any order).
2. Place the two supplied Ethernet terminators on the first and last speakers in the chain.
3. Finally, set each speaker's rear panel DIP switches according to its position in the system. For example, place the DIP switch labeled LEFT in the up (ON) position for the speaker reproducing the left channel, and place the DIP switch labeled RIGHT in the up (ON) position for the speaker reproducing the right channel. To set the DIP switch, gently push the white plastic nub of using a small flat blade screwdriver, a toothpick or other narrow object. Only one DIP switch should be in the up (ON) position.

Reference - AC Power Connections/Network Connections and DIP Switch Settings

The illustrations below show typical network interconnections for both stereo and surround sound use.

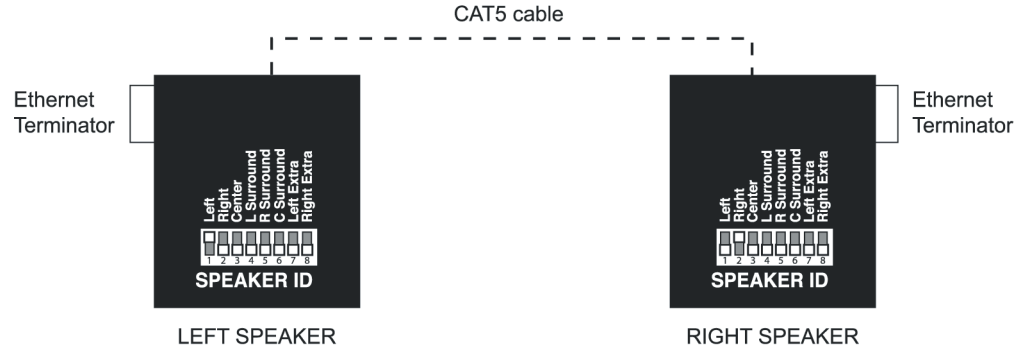

Networking interconnections and DIP switch settings for stereo use

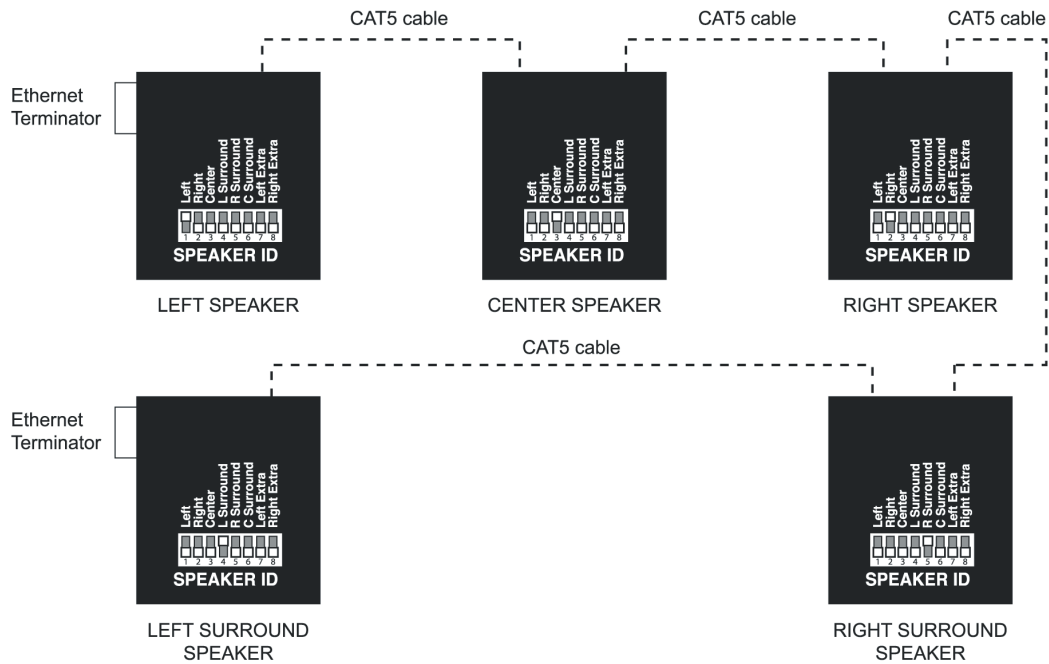

Networking interconnections and DIP switch settings for surround use

At least one LSR4300 monitor in a networked system **must** have its LEFT DIP switch set to ON.

When using only a single speaker, set the LEFT DIP switch to ON, regardless of the speaker's physical position in the room.

If required, LSR4300 monitors can be used without being networked together (i.e., without any CAT5 cable interconnections). In this case, the LEFT DIP switch in every speaker must be set to the ON position and all other DIP switches in every speaker must be in the OFF position.

Audio Connections

The LSR4328P and LSR4326P speakers are equipped to accommodate a range of analog and digital signal input sources. You can connect two digital sources and one analog source to each speaker and switch between them using front panel controls, or the wireless remote control and/or LSR4300 Control Center software.

Analog Connections

Positive voltage to Pin 2 of the XLR connector or the tip of the ¼" jack will produce a forward motion in the speaker cone. See Appendix C in this manual for wiring diagrams. Analog signal sources must be connected to **either** the rear panel XLR or ¼" connector.

⚠ Do not connect analog signal to both the XLR and ¼" inputs; use one or the other.

The LSR4300 provides switchable input sensitivity between +4 dBu and -10 dBV, as determined by the two-position Input Sensitivity switch on the rear panel.

When the sensitivity is set for +4 dBu, an input signal equal to +4 dBu will produce a system output level of 94 dB SPL at a distance of one meter. Likewise, a setting of -10 dBV will cause an input level of -10 dBV to attain the output acoustic level of 94 dB SPL at a distance of one meter. Use of the front panel Volume control (that is, pressing the +/- button when no button is flashing) allows further level matching.

Incoming analog signal is internally routed to the LSR4300's high resolution 96kHz, 24-bit, oversampling A/D converters.

Digital Connections

Connect digital sources in AES/EBU format to the rear panel XLR digital input connector and those in S/PDIF format to the rear panel phono digital input connector. The following sample rates are supported: 96kHz, 88.2kHz, 48kHz, 44.1kHz, 32kHz, with word lengths of up to 24 Bits.

AES/EBU and S/PDIF digital audio is transmitted as a two-channel pair on a single cable. Each LSR4300 speaker can reproduce only one channel at a time: either the left "A" channel or the right "B" channel. The channel reproduced is determined by the speaker's DIP switch settings, as per the chart below. For example, when the leftmost ("Left") DIP switch is ON, the speaker will reproduce Channel A of the incoming stereo digital data stream.

When the following DIP Switch is in the ON position:	The speaker will reproduce Channel:
LEFT	A
RIGHT	B
CENTER	A
LEFT SURROUND	A
RIGHT SURROUND	B
CENTER SURROUND	A
LEFT EXTRA	A
RIGHT EXTRA	B

Reference - Audio Connections/RMC™ Room Mode Correction

To route an incoming AES/EBU two-channel signal to another speaker, use a cable with XLR plugs on both ends to connect the AES/EBU OUT of the first speaker to the AES/EBU IN of the second speaker.

To route an incoming S/PDIF two-channel signal to another speaker, use a cable with phono plugs on both ends to connect the S/PDIF OUT of the first speaker to the S/PDIF IN of the second speaker.

For best results when using digital inputs, always use high-quality cable designed for use with digital equipment. We recommend the use of 110 ohm cabling for AES/EBU connections and 75 ohm cabling for S/PDIF connections.

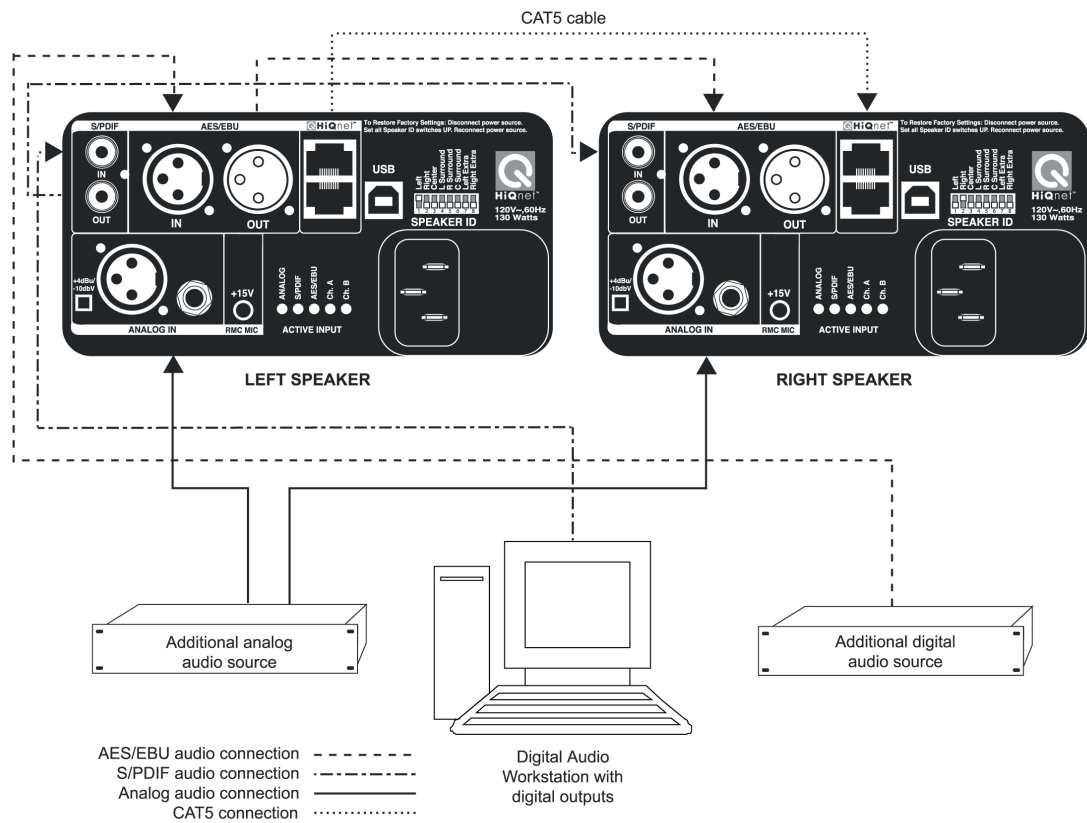

LSR4300 audio interconnections

RMC™ Room Mode Correction

When a loudspeaker is placed in any work space, it and the room behave as a system which, for better or worse, acts as the reference point for creative decisions. When a room has inadequate or incorrect acoustic treatment, “room modes” (sometimes called “standing waves”) can result, producing low frequency resonances that give a misleading impression of bass response and therefore make it difficult to achieve a proper mix balance.

The LSR4300 utilizes a revolutionary technology called RMC™ (short for “Room Mode Correction”) that is designed to correct the problem. RMC analyzes the frequency response of

the speakers at the mix position and automatically applies corrective filters to dramatically minimize low frequency resonances. Because room modes create resonance at specific frequencies with very narrow bandwidths (sometimes called “Q”), the on-board analyzer has the intelligence to identify the specific frequency and Q and apply a corrective parametric filter to only the component of the signal that excites the problem. The LSR4300 RMC system can place a parametric filter at 73 frequencies (1/24th octave centers) between 20 Hz and 160 Hz, with a variable Q from 1 (1-2/5 octave bandwidth) to 16 (1/11 octave bandwidth), with 3 to 12 dB of attenuation.

When the calibration mic is connected and the RMC analysis is initiated with the press of a single button, the LSR4300’s onboard computer emits a reference tone that is measured at the mix position using the supplied calibration microphone. The computer measures the response received via the microphone and compares it with the original tone being emitted. It determines which if any conditions should be corrected, and then calculates and applies a corrective filter. The entire process takes only a few seconds per speaker.

During the RMC calibration process, the computer trims speaker levels in fine 0.25 dB increments so that all speakers in the system produce equal SPL (sound pressure level) at the mix position. This feature is particularly useful in surround sound applications where space limitations often prevent optimum speaker placement. For example, if the center speaker is closer to the mix position than the other main speakers, attenuation must be applied so your mix balances are correct. Without this correction, your end product will sound unbalanced on a properly calibrated playback system.

Performing An RMC Calibration

To get the benefit of JBL’s revolutionary RMC technology, RMC calibration should be performed. The RMC calibration process is simple and easy, taking only a few moments to complete. RMC settings remain in memory even after the speakers are powered down, so typically the process only needs to be performed one time. RMC calibration should be performed:

- The first time you use your LSR4300 monitors. (The front panel RMC button will be lit to remind you of that).
- When the LSR4300 monitors are relocated, repositioned, or moved into a different listening space (either a different room altogether or a different area within the same room).
- After any kind of change to the room’s acoustic treatment (such as adding carpeting, bass traps, or other kinds of diffusers).
- When there is a significant change to the room’s furnishings (such as adding a console enclosure, a sofa, or other large piece of furniture).

◀ RMC settings created in a prior environment are not relevant to the new environment. If you do not wish to recalibrate the LSR4300 system after repositioning or moving one or more speakers, press the RMC switch to bypass the existing settings.

Reference - Performing An RMC Calibration

Following are step-by-step instructions for performing an RMC calibration:

1. Make sure all LSR4300 monitors are positioned as intended.
2. Using the mic clip, attach the provided calibration microphone to a mic stand and place the mic at the mix position, oriented vertically, at ear level. Be sure that it is no closer than 1.5 feet (.46 meters) from the nearest speaker.

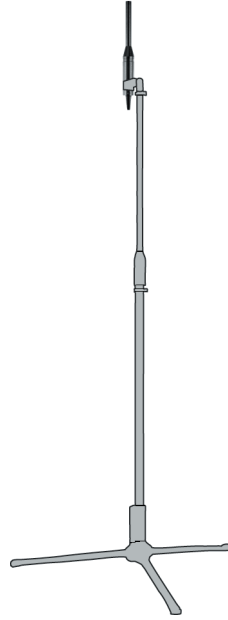

Position the calibration microphone vertically

3. Connect the microphone to the Left speaker's rear panel RMC MIC input.

🔊 To perform RMC, the calibration microphone must be connected to the speaker designated as "Left" (LEFT DIP switch up).

4. Press and hold the RMC button on any speaker for at least 3 seconds (until the RMC light on the front panel of all speakers begins blinking), then walk to a spot in the room where you are not blocking the path between the microphone and any speaker.

Reference - Performing An RMC Calibration

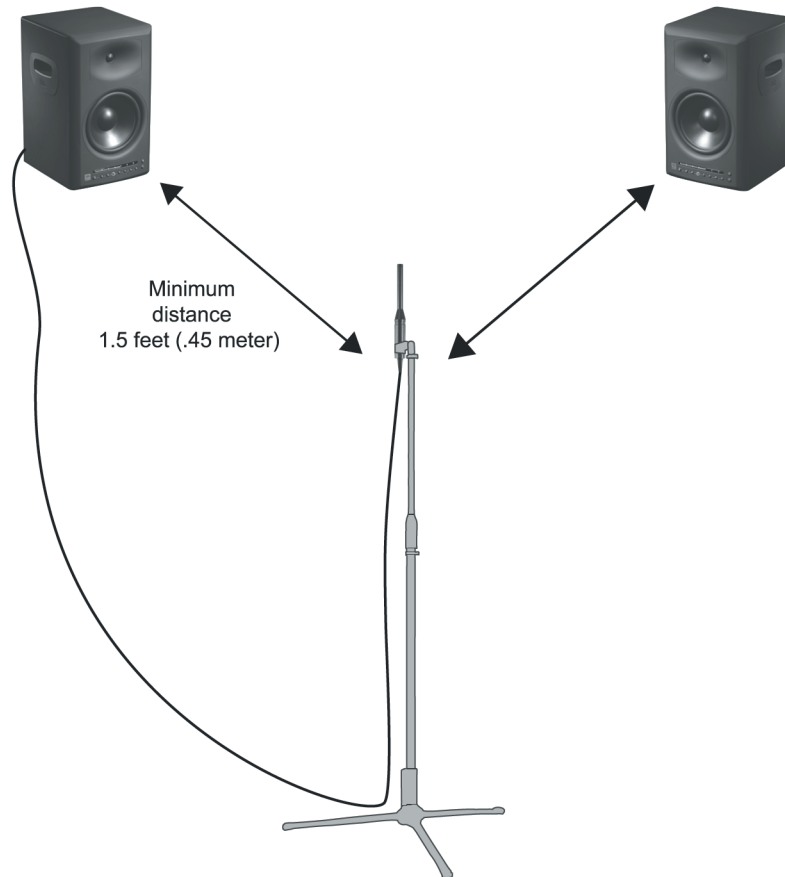

Do not block the signal coming from any speaker while performing RMC calibration.

- Each speaker in the system will sequentially emit a reference tone and its meter will show a left-to-right “chase” pattern that indicates the system is calibrating.

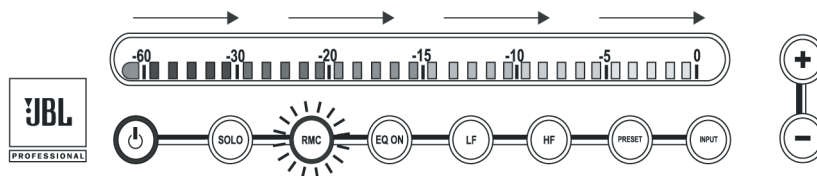

⏸ The RMC procedure produces a fairly loud swept sine wave calibration tone that can surprise you when you hear it for the first time. After pressing the RMC button, move away from the speaker. There is a five second delay prior to the sounding of the calibration tone.

- When the “chase” pattern on the meters stops and the RMC button on all speakers stops blinking, the process is complete. Disconnect the microphone and store it in its protective bag and carton for future use.

Reference - Performing An RMC Calibration/Equalization

⚠ The supplied calibration microphone must be connected to perform RMC. If the RMC button is pressed and held for 3 seconds or longer and no mic is connected, the meter display will flash to indicate an error condition, and all RMC settings currently in memory will be erased.

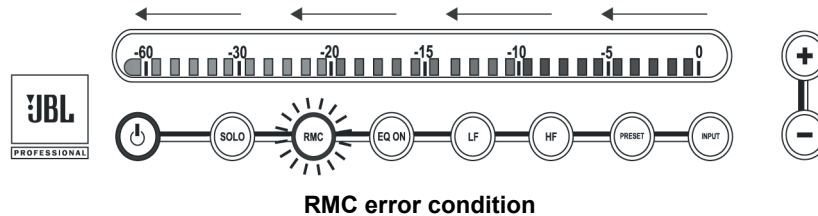

To bypass the calibrated settings and compare the original, uncompensated performance with the corrected performance, press the RMC button so that it lights up. This allows you to listen to the speaker without the filter, delay, level trim and meter calibration applied during the RMC process. To restore RMC functions, press the button again. The button will no longer be illuminated.

Equalization

Equalization is provided to tailor response to preference, or acoustic conditions in the room. The LSR4300 offers two bands of onboard digital equalization (high and low frequency), with up to 2 dB of cut and boost in each band. The equalization is shelving type with centers of 500 Hz for low frequency and 2 kHz for high-frequency. Using the supplied LSR4300 Control Center software, the corner frequency for each band is adjustable from 20 Hz to 1 kHz (LF) and 1 kHz and 20 kHz (HF).

To turn equalization on, press the EQ button on any networked speaker so that it lights up. The LF and/or HF buttons immediately to the right of the EQ button will also light up if the current setting contains LF or HF boost or cut. (If the current EQ setting contains “flat” LF or HF equalization – that is, no boost or cut – the associated button will not light.)

To apply equalization, simply press the LF or HF button (it will begin blinking), followed by the +/- buttons. The meter display LEDs will light (all in green) to show you the amount of cut or boost. If only the two LEDs on either side of the center (-15) mark are lit, that is an indication that the selected equalization band is flat (i.e., no cut or boost). LEDs lit to the right of center (that is, to the right of the -15 mark) indicate the amount of equalization boost, while LEDs lit to the left of center (that is, to the left of the -15 mark) indicate the amount of equalization cut. With every 0.25 dB of equalization boost or cut, an additional two LEDs light. Thus, for example, an equalization boost of 1 dB is indicated by eight LEDs lit to the right of the center (-15) mark.

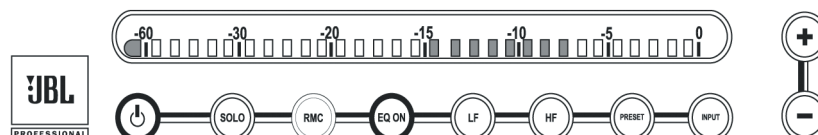

The LSR4328P and LSR4326P provide six factory EQ presets. (A complete listing of all parameters for the factory presets is presented in Appendix A). To recall a preset, press the front panel PRESET button on any networked speaker (it will begin blinking), then use the + or – buttons to select the desired preset. Preset 1 is indicated by the left-most block of five LEDs lighting green, and each successive block of five LEDs indicates the next preset. Thus, for example, if you see the right-most block of five LEDs lit, that is an indication that you are calling up Preset 6. If no preset is selected while the PRESET button is flashing (for about 3 seconds) the system will return to its current settings. See page 31 in this manual for illustrations showing the LED display for each preset.

Preset 0 is a special case. Indicated by the lighting of a single LED on either side of the center (-15) mark, this is the user memory area, which always contains a copy of the last recalled preset. Changes made to preset 0 remain in memory even after the LSR4300 is powered down; however, they are lost when one of the six factory presets is recalled. If this preset is selected prior to the time-out of the preset function, no change is made to the current settings. LSR4300 Control Center software allows the creation and storage of custom user equalization curves, which can then be loaded into memory, overwriting any of the factory presets. For more information, see the LSR4300 Control Center owner's manual. Additionally, the Control Center Software allows you to select the frequency of EQ boost or attenuation.

Whenever a preset is selected, the LF and HF buttons will illuminate to indicate whether the currently selected preset contains LF and/or HF boost or cut (the button corresponding to the most recently changed band will flash). The preset becomes active when the PRESET button stops flashing (after 3 seconds). If no preset is selected, the system will return to its current settings. If preset "0" is selected before the 3 second time-out of the function, no change is made to the EQ settings.

Equalization presets can be stored in memory or to disk with the use of the supplied LSR4300 Control Center software. Changes made to a preset are held in memory even when the LSR4300 is powered down; however, without the use of the software, any changes made will be lost when another preset is called up.

◀ A preset can be deactivated by pressing the EQ ON button until the light goes out, or by manually setting both the LF and HF values to 0 dB.

Restoring Factory Settings

Setting all DIP Switches to the ON position and re-powering a speaker clears all user settings (such as RMC calibration and EQ settings) stored in the speaker's memory.

To clear the memory of a speaker and recall the factory EQ presets:

1. Turn the speaker off and disconnect its power cable.
2. Set all eight DIP switches to the ON position.
3. Re-connect the power cable, wait for the speaker logo to dim, and turn the speaker back on. All front panel controls will blink and the LED display will flash a left-right pattern to show that memory settings are being recalled.
4. Reset all DIP switches to the desired positions for network operation.
5. Perform this procedure for each speaker that requires it.

Settings created using LSR4300 Control Center Software such as individual speaker level trim, custom eq presets can not be viewed with out the software. If you are unsure of the settings in the speaker, the speaker can be returned to factory settings using the Reset function.

🔊 User settings such as RMC and EQ remain stored in each speaker, even when powered down. For that reason, if you are using an LSR4300 system that you did not personally set, it's a good idea to restore factory settings before using it.

LSR4300 Control Center Software

The supplied LSR4300 Control Center Software allows you to control all system functions using a Windows or Macintosh computer. In addition, the software allows you to view multiple speaker parameters at once in an easy-to-use graphic display and provides several additional capabilities:

- System MUTE and independent speaker MUTE controls.
- Independent fine speaker Level Trim controls in 0.25 dB increments.
- The RMC filter and level trim settings of each speaker can be viewed.
- LF and HF frequency centers of the system EQ can be adjusted.
- Custom EQ presets can be created and stored as well as uploaded to all speakers on a connected LSR4300 network.
- Complete system configurations can be saved to and loaded from your computer.

LSR4300 Control Center Software documentation is provided on disk and is also available for download (along with the latest version of the software itself) at www.jblpro.com.

Appendix A: EQ Presets

◀ All factory EQ presets use an LF corner frequency of 500 Hz and a HF corner frequency of 2.0 kHz.

- **Preset 1:** LF 0 dB, HF = +2.0 dB

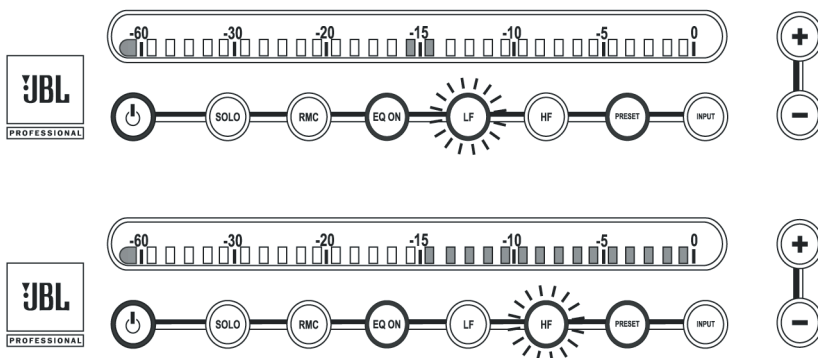

- **Preset 2:** LF +1.5 dB, HF = 0 dB

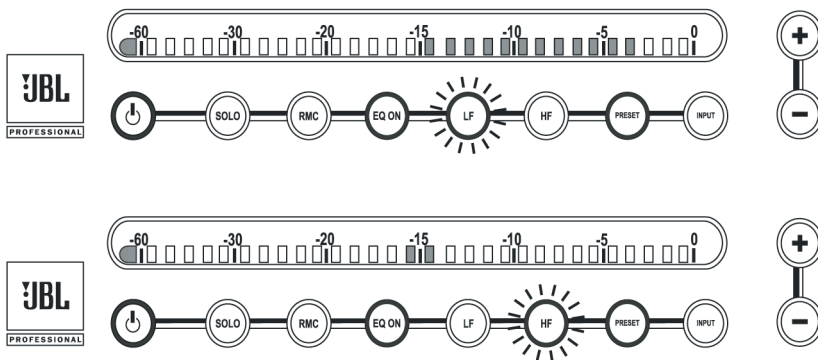

- **Preset 3:** LF +2.0 dB, HF = +2.0 dB

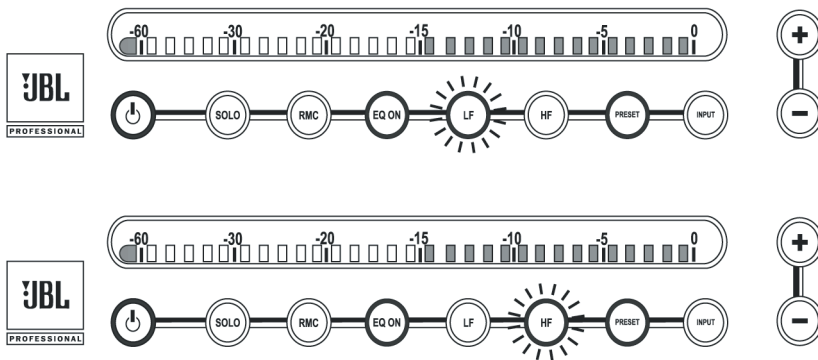

Appendix A: EQ Presets

- Preset 4: LF 0 dB, HF = -1 dB

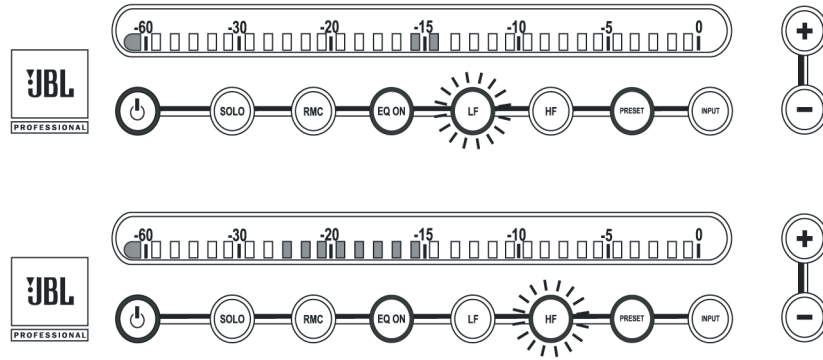

- Preset 5: LF 0 dB, HF = -2 dB

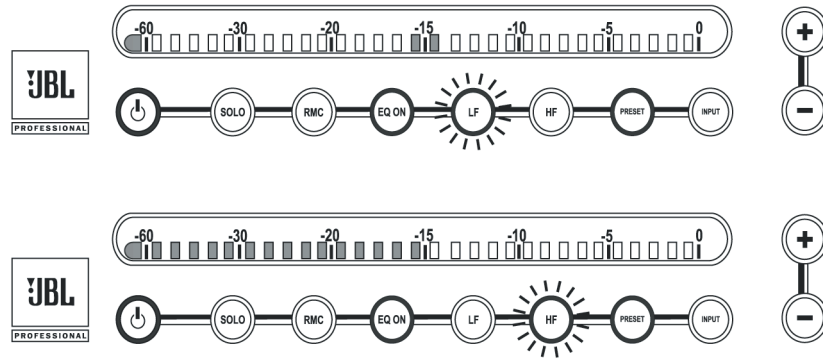

- Preset 6: LF -1.5 dB, HF = 0 dB

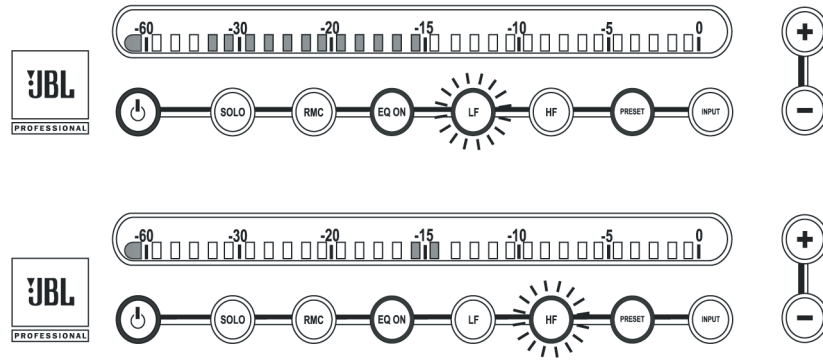

Appendix B: System Block Diagram

Signal Flow

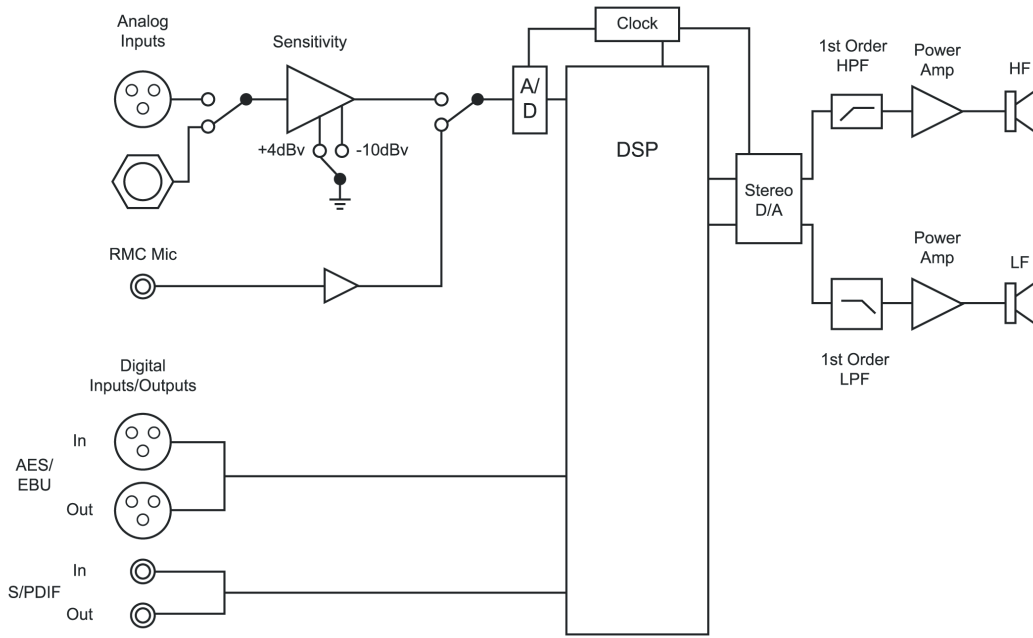

DSP

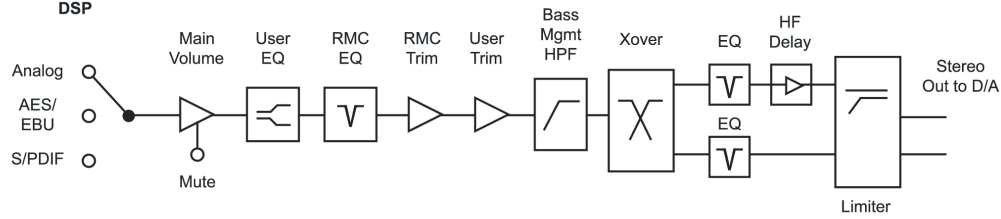

Appendix C: Wiring Requirements

Analog Connections

For optimum performance, some attention to wiring details now can reduce system degradation later. The cabling recommendations given below follow standard wiring practice for differential inputs.

Balanced Sources

The best way to run your system is balanced, where both “HOT” (+) and “COLD” (-) signals are supplied from the source along with a GROUND/SHIELD. These are typically carried on 2 conductor shielded cables with XLR connectors on both ends.

Alternatively, connectors with Tip, Ring and Sleeve (T/R/S) jacks can be used. Whenever possible, the cable shield should not be connected to any signal pin, but left to perform a cable shielding function only. Note:

Under no circumstances should the safety ground wire be removed from the AC power connector.

When using balanced sources with the LSR4328P or LSR4326P, either the XLR or T/R/S input connector can be used, since the circuit is common to both. However, both inputs should not be used simultaneously.

For balanced signals, the HOT (+) signal from your source should be connected to the tip of the T/R/S connector or Pin 2 of the XLR input as shown in Diagram A. The “COLD” (-) signal should be connected to Pin 3 of the XLR or the “Ring” of the T/R/S connector. To avoid ground loops, connect the SHIELD at the source end but not at the LSR input.

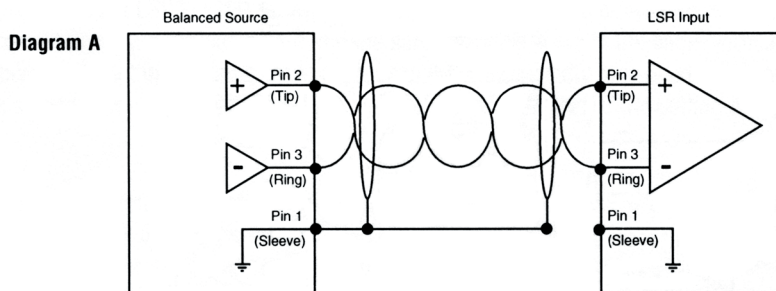

Appendix C: Wiring Requirements

Unbalanced Sources

When using unbalanced sources, there are more possibilities to introduce ground loops into a system. The LSR4328P and LSR4326P offer several ways to help alleviate potential problems with unbalanced equipment.

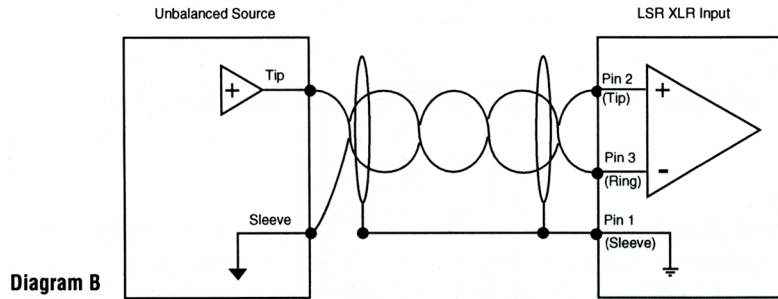

While there are only HOT and GROUND/SHIELD connections from unbalanced sources, it is recommended that high quality twisted pair cable be used. Diagram B shows an unbalanced source connected to the balanced XLR input of the LSR monitor using twisted pair cable. Note that the shield is connected to the GROUND/SHIELD connector at the LSR input, but not at the source. This reduces the likelihood of introducing a ground loop into the system.

When using unbalanced signals with an LSR4328P or LSR4326P, we recommend using 1/4" Tip/Ring/Sleeve connections. As shown in Diagram C, when using the 1/4" Tip/Ring/Sleeve or XLR connection, the GROUND should be tied to the source -- not the sleeve -- of the LSR input for optimum performance.

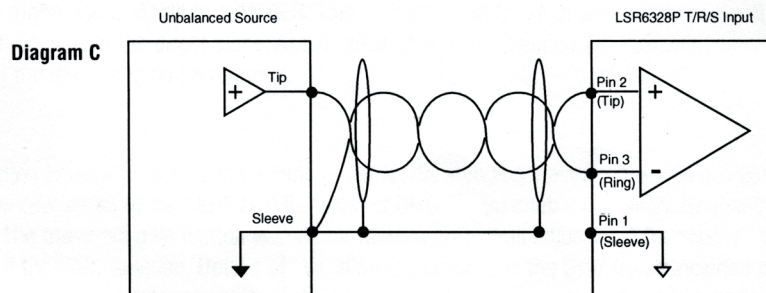

Appendix C: Wiring Requirements

Diagram D details the connections using single conductor shielded cable with a Tip/Ring/Sleeve or XLR plug for the LSR4328P / LSR4326P input. Single conductor cable should be used as a last resort as it provides the greatest likelihood of problems. The “HOT” (+) signal should be connected to the tip of the Tip/Ring/Sleeve plug. The GROUND should be attached to the Ring of the Tip/Ring/Sleeve plug at the LSR4328P / LSR4326P input.

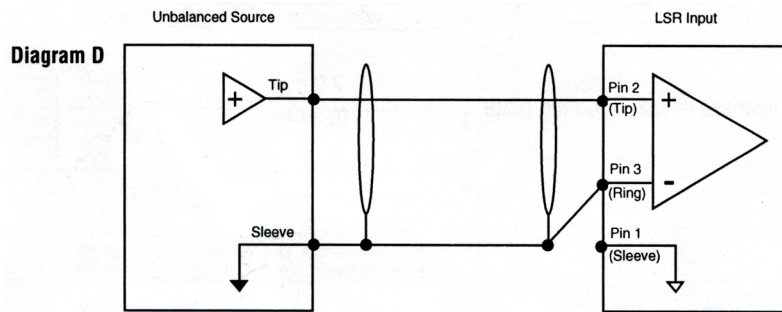
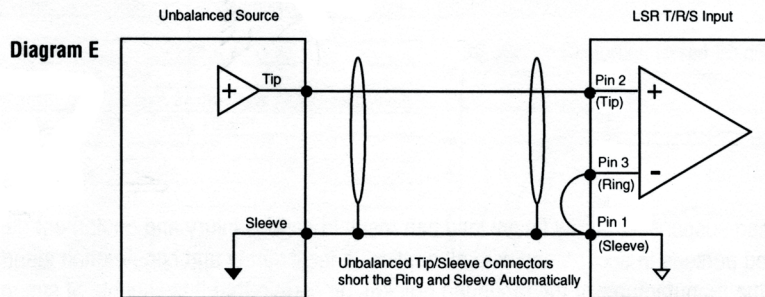

Diagram E details the connections using unbalanced cable and Tip/Sleeve connections to the 1/4" or XLR input.



Digital Audio Connections

Always use high-quality cable designed for use with digital equipment.

We recommend the use of 110 ohm balanced cabling for AES/EBU connections, with a maximum cable length of 100 meters (approximately 330 feet). 75 ohm cabling should be used for S/PDIF connections, with a maximum cable length of 10 meters (approximately 33 feet).

Appendix D: Mounting Specifications

Mounting points are provided for use with readily available industry standard mounting brackets. Mounting points are located on the bottom of the LSR4328P and LSR4326P models.

Fastener specifications

Type: M6 metric thread

Length: 1 inch (25.4 mm) plus the thickness of the mounting plate.

Hole Pattern:

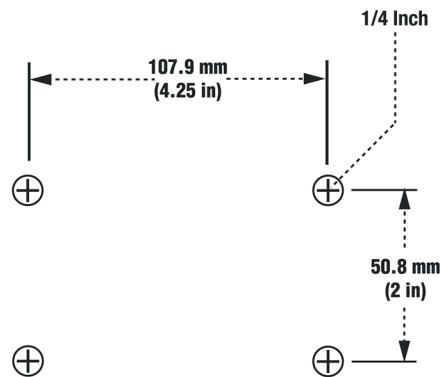

Caution: Unsafe mounting or overhead suspension of any heavy load can result in serious injury and equipment damage. Mounting of speakers should be done by qualified persons in accordance with all applicable local safety and construction standards. Be certain to follow the instructions provided by the manufacturer of the mounting bracket, be certain that it is capable of supporting the weight of the speaker to be mounted.

Appendix E: SPL Calibration

The chart below shows the SPL (Sound Pressure Level) delivered by the speaker when the listening position is 1 meter (3.3 feet), 2 meters (6.6 feet) and 3 meters (roughly 10 feet).

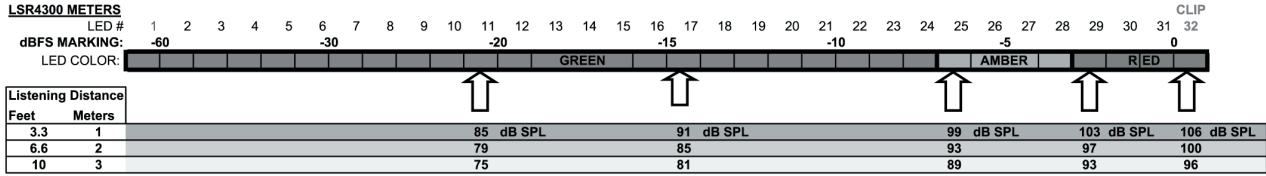

Example: When the -15 dBFS GREEN LED is lit:
 At a distance of 1 meter (3.3 feet) the SPL (Sound Pressure Level) at the listening position is 91 dB SPL.
 At a distance of 2 meters (6.6 feet) the SPL at the listening position is 85 dB SPL.
 At a distance of 3 meters (10 feet) the SPL at the listening position is 81 dB SPL.

You can create a visual reference for any listening distance using a readily-available Sound Pressure Level (SPL) meter and a pink-noise source. Here is the procedure for doing so:

1. Place the SPL meter at the mix position and turn it on.
2. Begin playing the pink noise source back through your LSR4300 speakers.
3. Using the +/- buttons, raise the LSR4300 system volume so that the first amber-colored LED (-10 dB) begins to flicker and note the amount registered in the SPL meter.

You now know the approximate SPL the speaker is contributing whenever the first amber LED begins to illuminate. Alternately, set the system volume to produce the desired SPL at the mix position and make a visual note of the illuminated meter segment that correlates to the desired SPL. Using LSR4300 Control Center Software, you can store and recall a system volume setting that produces your desired SPL.

Appendix F: Error Messages and Troubleshooting

Under certain circumstances, the meter display on the speaker will indicate an “error message.” Following is a list of conditions that cause an error message to be displayed, and the corrective action required to cancel the error message.

LIST OF ERROR MESSAGES:

Error	Cause	Display Looks Like	Remedy
No Mic Found	Mic is not connected during RMC calibration	RMC button blinks and the meter lights sequentially from right to left	Press RMC to exit RMC. Connect mic and press and hold to calibrate.
Speaker ID Error	Improper DIP switch setting. Rear panel DIP switch on this speaker set to all switches off, or 2 or more speakers have same ID setting	All front panel buttons blink and the meter shows 5 segments moving back and forth on the speaker showing the error	Correct DIP switch settings.
Sync Signal Error	No digital signal found or loss of sync signal when the S/PDIF or AES/EBU digital input is selected.	The Input button will blink and the first meter LED will flash to show muted state	Confirm digital signal is connected.
MUTE	A speaker that is muted indicates mute is active. Speaker may be muted by pressing individual or system Mute button (in LSR4300 Control Center Software), or activating SOLO on another speaker.	First meter LED will blink. No other meter segments will be active.	Un-mute individual speaker or system mute, exit solo on other speakers.
Reset	Non-standard DIP switch configuration used to restore factory settings. This mode is entered by setting all DIP switches ON and re-powering the speaker.	All front panel buttons and meter flash rapidly to indicate reset.	Reset DIP switches so only a single DIP switch is active on each speaker and re-power.

Appendix F: Error Messages and Troubleshooting

Following is a list of common easily remedied issues. Consult this list if you are having any difficulties operating your speakers.

TROUBLESHOOTING LIST

Condition	Cause	Remedy
	Lack of network terminators	Install terminators in first and last speaker.
Volume setting seems low	DIM button on Remote Control is activated	Press DIM button on remote control to restore full volume. Caution – To prevent sudden jump in volume, lower the system volume setting prior to deactivating DIM control.
No Meter Display	Brightness control is turned down	Use the brightness control or hold +/- to enter the brightness mode, and push + until you have the brightness level you like.
The speaker will not output any audio, and the solo light on the front is blinking.	The Speaker is in SOLO mode.	In a networked system, press SOLO on the speakers that have their SOLO button blinking. If your system is no longer networked and the speaker is still muted, hard reset your loudspeaker.
I just finished connecting my system, but there is no audio.	Input selection is not set to match input source.	Make sure your input selection matches the inputs you are using (Analog, S/PDIF, AES/EBU).
I selected my digital input, but the audio keeps dropping out.	Poor connection, defective cable, or source is unstable.	Check connections and cables. Confirm you are using suitable cable of proper impedance. If cables and connections are OK, source may be unstable.
I am having trouble daisy- chaining my digital audio through multiple speakers.	Cable may not be suitable for digital application.	Make sure you are using cables per the S/PDIF and AES/EBU specification as described on page 39 in this manual.
My remote control doesn't work all of the time.	Batteries weak. Remote is not pointed at the receiver.	Make sure remote is pointed at the Front Left speaker (the speaker with LEFT DIP switch in the ON position).
My speaker will not power up. There are no lights at all anywhere on the speaker.	Speaker is not connected to power source or fuse is blown.	Confirm your speaker is connected to an active power source. Check the fuse. If blown, replace with the spare provided in the fuse holder in the IEC power connector. If speaker fails to power-up please call JBL Customer Service.
Upon boot –up, LSR4300 Control Center Software does not "recognize" connected speakers.	USB connection and/or Network cables not properly connected. Missing terminator.	Check all network connections to make sure the CAT5 cable is inserted all the way into each jack. Make sure you have two network terminators installed in your system so that all RJ485 jacks are in use. Confirm the USB cable from your computer is connected to the front left speaker (the speaker with LEFT DIP switch in the ON position).

Specifications

(Unless otherwise noted, all specifications are for both LSR4328P and LSR4326P models)

System		
	Frequency Response (+/- 1.5 dB):	50 Hz – 20 kHz (LSR4328P) 55 Hz – 20 kHz (LSR4326P)
	Enclosure Resonance Frequency:	41 Hz (LSR4328P) 52 Hz (LSR4326P)
	Low Frequency Extension:	User controls set to default
	-3 dB:	43 Hz – 22 kHz (LSR4328P) 47 Hz – 22 kHz (LSR4326P)
	-10 dB:	35 Hz – 32 kHz (LSR4328P) 39 Hz – 32 kHz (LSR4326P)
	Low-High Frequency Crossover:	Digital Crossover: 2.6k 4 th order BW LF/ 4 th order BW HF (LSR4328P) Digital Crossover: 2.8k 4 th order BW LF/ 2 nd order BW HF (LSR4326P)
	Distortion, 96 dB SPL, 1 m: Mid-High Frequency (200 Hz - 20 kHz)	
	2nd Harmonic:	<0.4%
	3rd Harmonic:	<0.3%
	Low Frequency (<200 Hz)	
	2nd Harmonic:	<1.5% (LSR4328P) <0.8% (LSR4326P)
	3rd Harmonic:	<0.7% (LSR4328P) <1.4% (LSR4326P)
	Maximum Continuous SPL :	106 dB / 1m
	Maximum Peak SPL:	112 dB / 1m
	Maximum Peak SPL Per Pair:	118 dB SPL / 1m
	Low Frequency Model:	438H (LSR4328P) 436H (LSR4326P)
	Diameter:	203 mm (8 in) (LSR4328P) 159 mm (6.25 in) (LSR4326P)
	Voice Coil:	2" (51 mm) (LSR4328P) 1.5" (38 mm) (LSR4326P)
	Magnet Type:	Neodymium
	Cone Type:	Polymer coated paper fiber
	Impedance:	8 ohms
	High Frequency Model:	431G
	Diameter:	25 mm (1 in) diaphragm
	Voice Coil:	1" (25 mm)
	Magnet Type:	Neodymium, shielded with integral heat sink
	Diaphragm Type:	Silk Dome
	Other Features:	Elliptical oblate spheroidal waveguide
	Impedance:	4 ohms
Amplifier		
	Low Frequency Topology:	Class A-B Monolithic, Balanced
	Sine Wave Power Rating:	150 watts (<0.1% THD into rated impedance)
	THD + N, ½ Power:	<0.02%
	High Frequency Topology:	Class A-B Monolithic
	Sine Wave Power Rating:	70 watts (<0.1% THD into rated impedance)
	THD + N, ½ Power:	<0.02%
	AC Input Voltage:	115 VAC, 60 Hz (230VAC, 50 Hz – models LSR4328P/230 and LSR4326P/230)
	AC Input Connector:	IEC
	Self-Generated Noise Level:	<13 dBA / 1 m tonal artifact-free noise floor

Specifications

	1/8 TH Power Rating:	13 watts LSR4326P, 18 watts LSR4328P
	Full Power Rating (100 hrs. IEC pink noise, 6dB crest Factor):	58 watts IEC Pink Noise LF Channel Only
	Wattage Rating:	AC at 1/8 th power IEC Pink Noise 60 watts
	Maximum Current:	AC at maximum power output (audio) 120V AC line 2.2A (LSR4328P, LSR4326P) 230V AC line 1.1A (LSR4328P/230, LSR4326P/230)
	Fuse Value:	1.25A, 250VAC, Time Lag (LSR4328P, LSR4326P) 2.5A, 250VAC, Time Lag (LSR4328P/230, LSR4326P/230)
Inputs and Outputs		
<i>Analog</i>	XLR IN:	Selectable +4 dBu/-10 dBV; Input Impedance 10K. Positive voltage applied to XLR pin 2 produces outward woofer motion
	¼-in tip-ring-sleeve IN:	Balanced or unbalanced, Selectable +4 dBu/-10 dBV; Input impedance 20K. Positive voltage applied to ¼" tip produces outward woofer motion
	AD Converters:	96kHz, 24 Bit, 64x Over sampling
	Calibrated Input Sensitivity, Analog XLR & ¼":	
	+4 dBu:	94 dB SPL / 1 m
	-10 dBV:	94 dB SPL / 1 m
<i>Digital</i>	XLR IN:	AES/EBU(IEC60958)
	XLR OUT:	AES/EBU(IEC60958)
	RCA IN:	S/PDIF , (EIAJ CP1201)
	RCA OUT:	S/PDIF (EIAJ CP1201)
	Digital Input Sample Rates:	96k Hz, 88.2 kHz, 48 kHz, 44.1 kHz, 32 kHz. Tolerance: +/- 3%
	Digital Input Word Length:	24 Bit
	RMC Microphone Input (Use supplied microphone only):	1/8" tip-ring-sleeve; powered +15 Volts on tip.
	Network Connection:	RJ45 IN, RJ45 OUT
	Network Protocol:	Proprietary HiQNet™ Protocol using RS485
	Computer Interface:	USB Type 1
User Controls		
	Front Panel Controls:	ON, SOLO, RMC, EQ ON, LF, HF, PRESET, INPUT, +/-
	RMC Functions:	Start, Bypass
	RMC Filter Range:	73 Frequencies (1/24 th octave centers) between 20 Hz to 160 Hz, with a variable Q from 1 (1.4 octave bandwidth) to 16 (1/11 th octave bandwidth, and from 3 to 12 dB of attenuation.
	LF EQ:	Factory Default: 500 Hz Shelf, +/- 2dB in ¼ dB increments. 137 corner frequencies between 19.7 Hz and 1kHz accessible via LSR4300 Control Center Software
	HF EQ:	Factory Default: 2kHz Shelf , +/- 2dB in ¼ dB increments 104 corner frequencies between 1kHz and 20.2 kHz accessible via LSR4300 Control Center Software
	PRESET:	1-6 Factory/User plus NULL. Recall only. STORE possible using LSR4300 Control Center Software.
	INPUT Selection:	Analog (XLR / ¼") S/PDIF A, B AES/EBU A, B
	+/-	Default: System Volume Control: 0 dB to ∞ dB Secondary functions: Increment/decrement value of selected function
	Rear Panel Controls:	Input sensitivity +4dBu/ -10dBV
		Eight SPEAKER ID DIP switches: Left, Right, Center, Left Surround, Right Surround, Center Surround, Left Extra, Right Extra

	<u>Additional Controls via LSR4300 Control Center Software:</u>	DIM (-12 dB at full volume), System MUTE, Preset STORE; LOAD Configuration, SAVE Configuration; Level TRIM +3 dB to - 10 db in ¼ dB increments
Display/		
	<u>Front Panel Display:</u>	31 LED Segments for dBFS and indication of settings
	<u>Front Panel Meter:</u>	-70 dBFS to 0 dBFS plus CLIP
	<u>Rear Panel Indicators:</u>	5 LED indicate Speaker ID Selection
Physical		
	<u>Finish:</u>	Dark graphite
	<u>Handles:</u>	2 each, flush mounted on sides
	<u>Mounting:</u>	4 threaded mounting points conforming to industry standard square pattern, 107.9 mm x 50.8 mm (4 ¼" x 2" in) center to center. M6 metric threads
	<u>Low Frequency Vent:</u>	Rear ported linear dynamics aperture
	<u>Baffle Construction:</u>	Injection-molded structural ABS
	<u>Enclosure Construction:</u>	19 mm (3/4 in) MDF
	<u>Net Weight:</u>	15 kg (32.5 lbs) (LSR4328P) 13 kg (28.5 lbs) (LSR4326P)
	<u>Dimensions (WxHxD):</u>	267 mm x 438 mm x 269 mm (10.5" x 17.25"D x 10.6") (LSR4328P) 236 mm x 387 mm x 262 mm (9.3" x 15.25" x 10.3") (LSR4326P)

Caution: Unsafe mounting or overhead suspension of any heavy load can result in serious injury and equipment damage. Mounting of speakers should be done by qualified persons in accordance with all applicable local safety and construction standards. Be certain to follow the instructions provided by the manufacturer of the mounting bracket. Before selecting a mounting bracket, be certain that it is capable of supporting the weight of the speaker to be mounted.

Notes:

All measurements unless otherwise stated made anechoically in a 4p environment at 2 meters, referenced to 1 meter by inverse square law.

The reference measurement microphone position is located perpendicular to the centerline of the low and high frequency transducers at the point 63.5 mm (2.5 in) below the center of the high frequency diaphragm.

Acoustic loading provided by the listening room increases maximum SPL capability and low frequency bass extension as compared to stated anechoic values.

Distortion measurements performed with the input voltage necessary to produce the stated A-weighted SPL at the stated measurement distance. Distortion figures refer to the maximum distortion measured in any 1/10th octave wide band in the stated frequency range.

JBL continually engages in research related to performance improvements. New materials, production methods, and design refinements are introduced into existing products without notice as a routine expression of that philosophy. For this reason, any current JBL product may differ in some respect from its published description, but will always equal or exceed the original design specification unless otherwise stated.

Warranty Statement

Who Is Protected by This Warranty?

Your JBL Warranty protects the original owner and all subsequent owners so long as: A.) Your JBL product has been purchased in the Continental United States, Hawaii or Alaska. (This Warranty does not apply to JBL products purchased elsewhere except for purchases through military outlets. Other purchasers should contact the local JBL distributor for warranty information.); and B.)

The original dated bill of sale is presented whenever warranty service is required. The JBL Limited Warranty on professional loudspeaker products (except for enclosures) remains in effect for five years from the date of the first consumer purchase. JBL amplifiers are warranted for three years from the date of original purchase. Enclosures and all other JBL products are warranted for two years from the date of original purchase.

What does the JBL Warranty cover?

Except as specified below, your JBL Warranty covers all defects in material and workmanship. The following are not covered: Damage caused by accident, misuse, abuse, product modification or neglect; damage occurring during shipment; damage resulting from failure to follow instructions contained in your Instruction Manual; damage resulting from the performance of repairs by someone not authorized by JBL; claims based upon any misrepresentations by the seller; any JBL product on which the serial number has been defaced, modified or removed.

Who Pays for What?

JBL will pay all labor and material expenses for all repairs covered by this warranty. Please be sure to save the original shipping cartons because a charge will be made if replacement cartons are requested. Payment of shipping charges is discussed in the next section of this warranty.

How to Obtain Warranty Performance?

If your JBL product ever needs service, write or telephone us at JBL Incorporated (Attn: Customer Service Department), 8500 Balboa Boulevard, PO. Box 2200, Northridge, California 91329 (800/852-5776). We may direct you to an authorized JBL Service Agency or ask you to send your unit to the factory for repair. Either way, you'll need to present the original bill of sale to establish the date of purchase.

Please do not ship your JBL product to the factory without prior authorization. If transportation of your JBL product presents any unusual difficulties, please advise us and we may make special arrangements with you. Otherwise, you are responsible for transporting your product for repair or arranging for its transportation and for payment of any initial shipping charges. However, we will pay the return shipping charges if repairs are covered by the warranty.

Warranty Statement

Limitation of Implied Warranties

ALL IMPLIED WARRANTIES, INCLUDING WARRANTIES OF MERCHANTABILITY AND FITNESS FOR PARTICULAR PURPOSE, ARE LIMITED IN DURATION TO THE LENGTH OF THIS WARRANTY.

EXCLUSION OF CERTAIN DAMAGES

JBL'S LIABILITY IS LIMITED TO THE REPAIR OR REPLACEMENT, AT OUR OPTION, OF ANY DEFECTIVE PRODUCT AND SHALL NOT INCLUDE INCIDENTAL OR CONSEQUENTIAL DAMAGES OF ANY KIND. SOME STATES DO NOT ALLOW LIMITATIONS ON HOW LONG AN

IMPLIED WARRANTY LASTS AND/OR DO NOT ALLOW THE EXCLUSION OF INCIDENTAL OR CONSEQUENTIAL DAMAGES, SO THE ABOVE LIMITATIONS AND EXCLUSIONS MAY NOT APPLY TO YOU. THIS WARRANTY GIVES YOU SPECIFIC LEGAL RIGHTS, AND YOU MAY ALSO HAVE OTHER RIGHTS, WHICH VARY, FROM STATE TO STATE.

JBL Professional Contact Information

Mailing Address:

JBL Professional
8500 Balboa Blvd.
Northridge, CA 91329

Shipping Address:

JBL Professional
8370 Balboa Blvd., Dock D
Northridge, CA 91329

Customer Service:

Monday through Friday
8:00am - 5:00pm
Pacific Coast Time In the U.S.A.
(800) 8JBLPRO (800.852.5776)
www.jblproservice.com

On the World Wide Web:

www.jblpro.com

Product Registration:

Register your product online at www.jblpro.com/registration

Outside the USA:

Contact the JBL Professional Distributor in your area. A complete list of JBL Professional international distributors is provided at our U.S.A. website - www.jblpro.com

En Dehors des Etats-Unis:

Contactez votre Distributeur JBL Professional. Une liste complète de nos distributeurs internationaux est disponible sur le site web - www.jblpro.com

International:

Wenden Sie sich an Ihre örtliche JBL Professional Vertretung.
Eine vollständige Liste der internationalen JBL-Vertretungen
finden Sie auf unserem Website unter www.jblpro.com

Fuera de los Estados Unidos:

Comuníquese con el distribuidor de JBL Professional de su zona. En nuestro sitio web, www.jblpro.com, encontrará una lista completa de los distribuidores de JBL International.

